

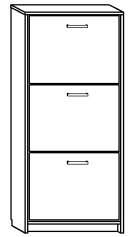

ATHENA 3/60L

→ 56 131 20



| | | | | | | | |
|--------------|---------|-------------------|---------|----------------------|----------------------|---------|----------|
| x 20 | x 8 | x 8 | x 6 | x 6 | x 3 | | |
| x 2 | x 4 | x 3 | x 2 | x 40 (3,5x16) | x 18 (6,2x16) | x 2 | x 50 |
| x 3 kpl. | | x 1 (1210 mm) | | | | | |

1 - FAZY MONTAŻU

A - OZNACZENIE ELEMENTÓW

a - OZNACZENIE AKCESORIÓW

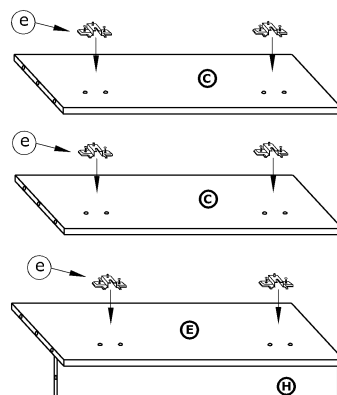
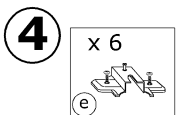
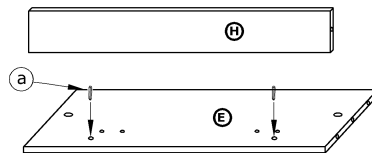
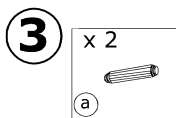
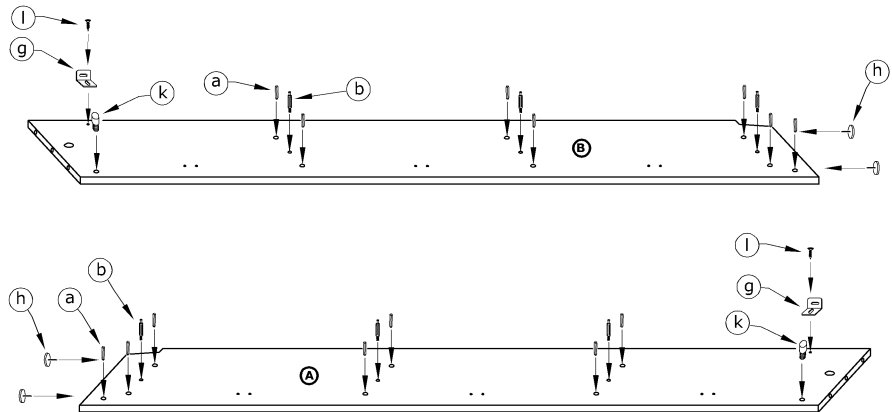
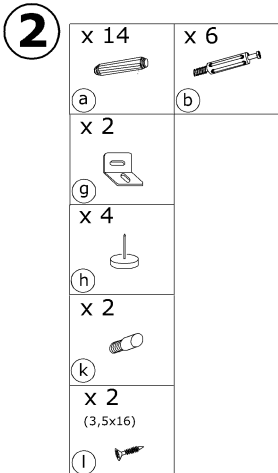
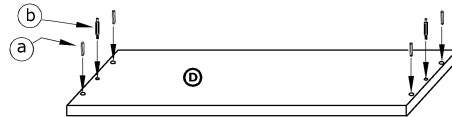
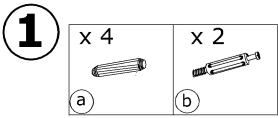

5

x 6

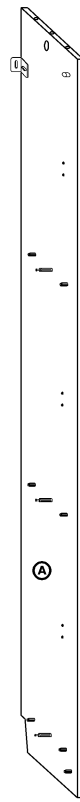
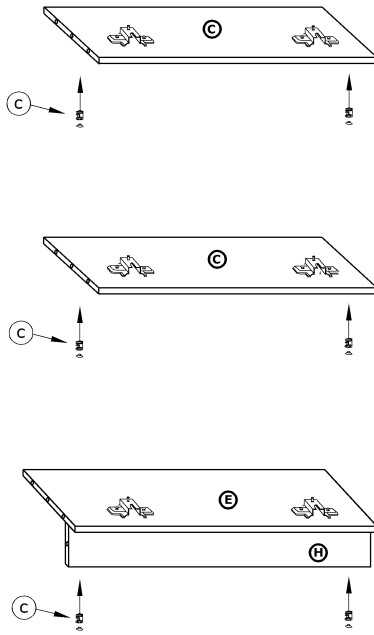
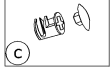

6

x 2

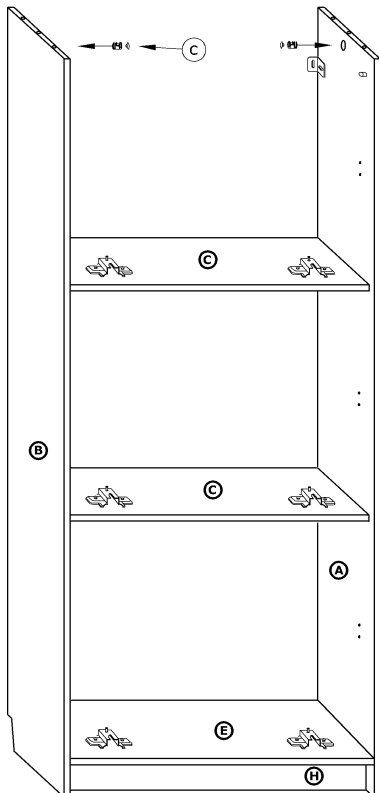
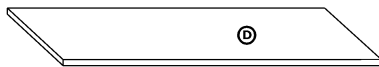
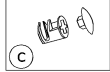

7

x 50

x 1

(1210 mm)

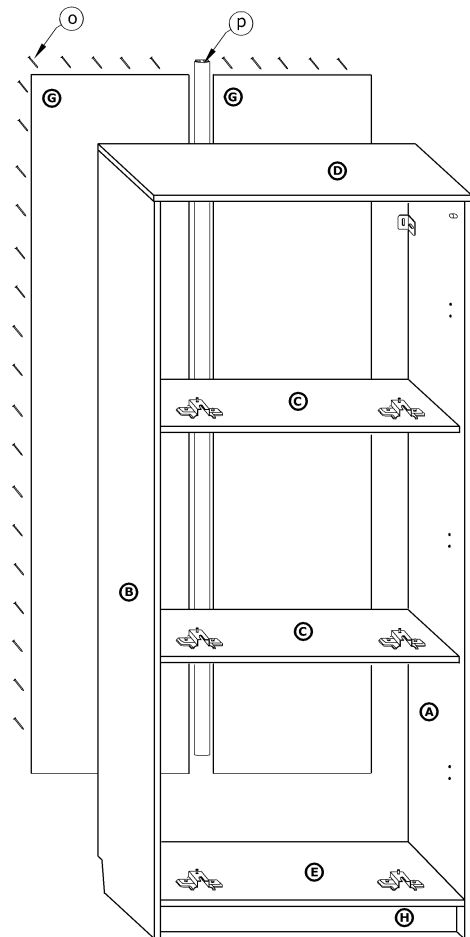
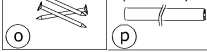

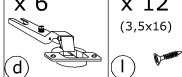

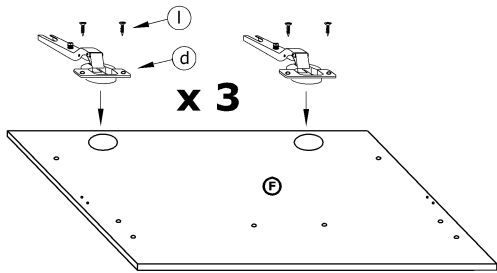

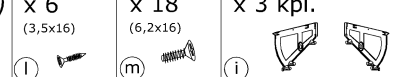
- 8**
- | | |
|-----|------------------|
| x 6 | x 12 (3,5x16) |
|-----|------------------|
- 

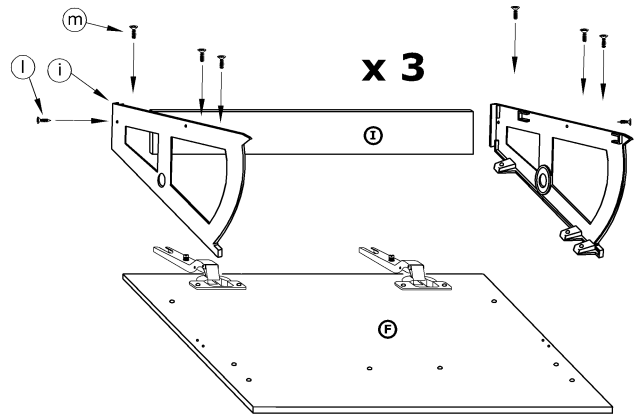

- 9**
- | | | |
|-----------------|------------------|----------|
| x 6 (3,5x16) | x 18 (6,2x16) | x 3 kpl. |
|-----------------|------------------|----------|
- 



- 10**
- | |
|---|
| x 3 |
|  |
| x 3 |
|  |
| x 18 (3,5x16) |
|  |
| x 2 |
|  |

