

















N1  L=35mm x 12	M1  12x15mm x 12	M2  ø16mm x 8	S1  3.5x16mm x 6	S2  6x8mm x 2	U4  x 2	K7  x 12
T1  x 5	Z1  x 80	A1  x 3	E1  8x30mm x 16	V3  x 1	U5  x 1	K2  x 1

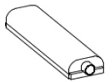

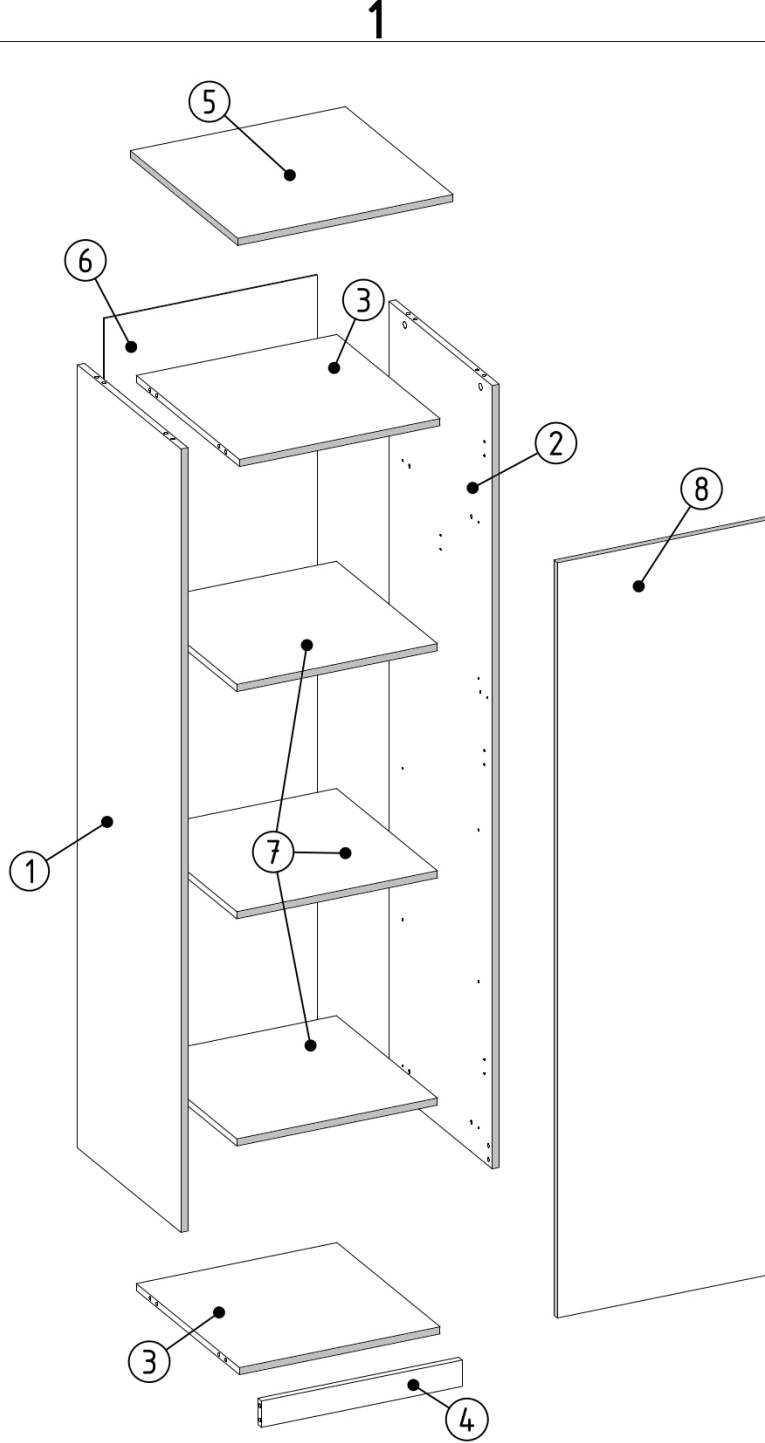
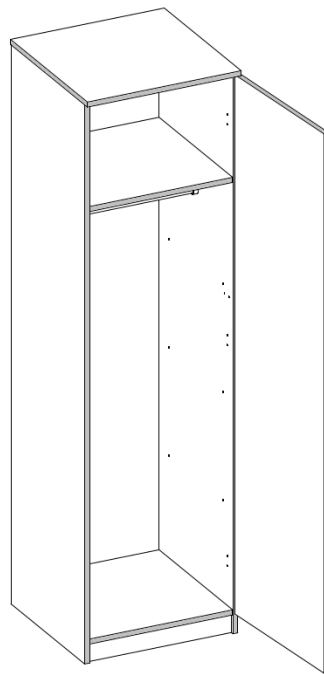
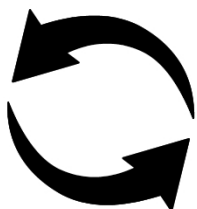
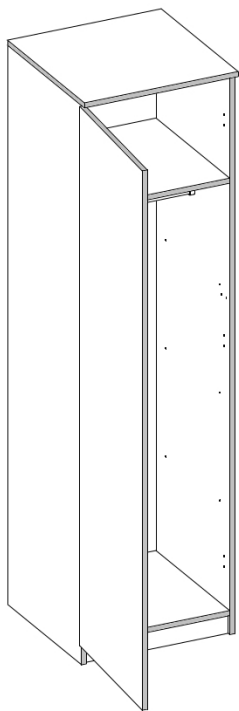
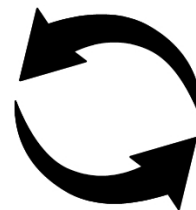
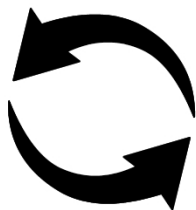
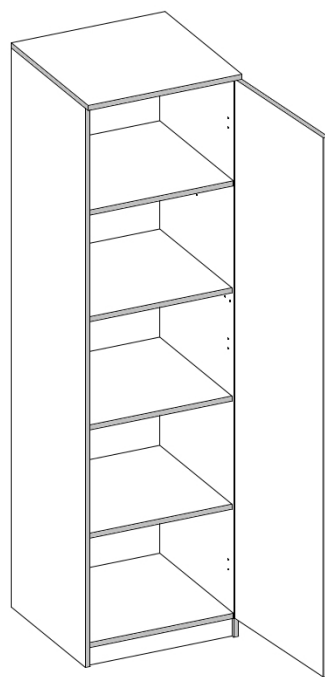
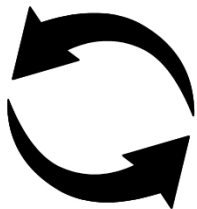
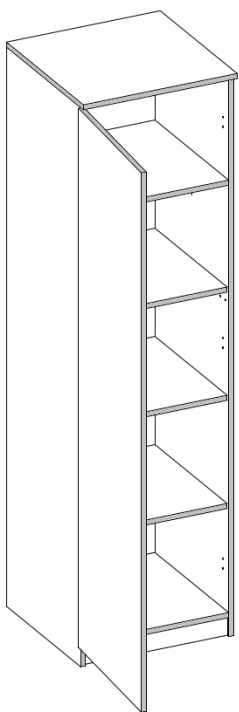



1	x	1
2	x	1
3	x	2
4	x	1

5	x	1
6	x	1
7	x	3
8	x	1

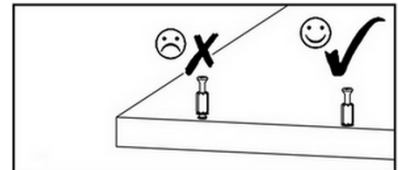
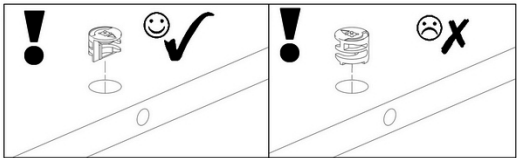
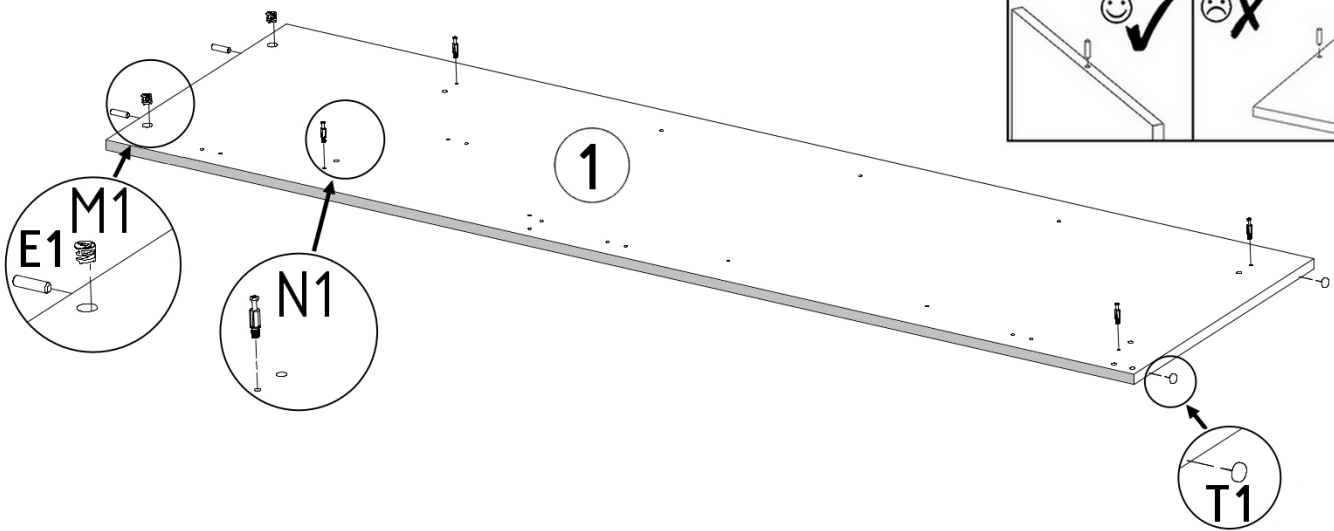
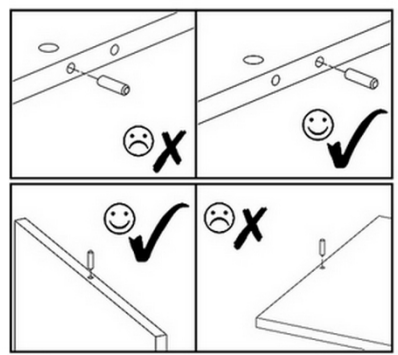

T1  x 2	M1  x 2	E1  x 2	N1  x 4
--	--	--	--



T1  x 2	M1  x 2	E1  x 2	N1  x 4
---	---	---	---

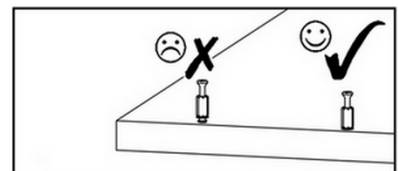
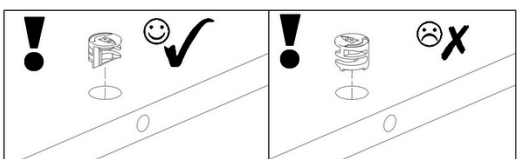
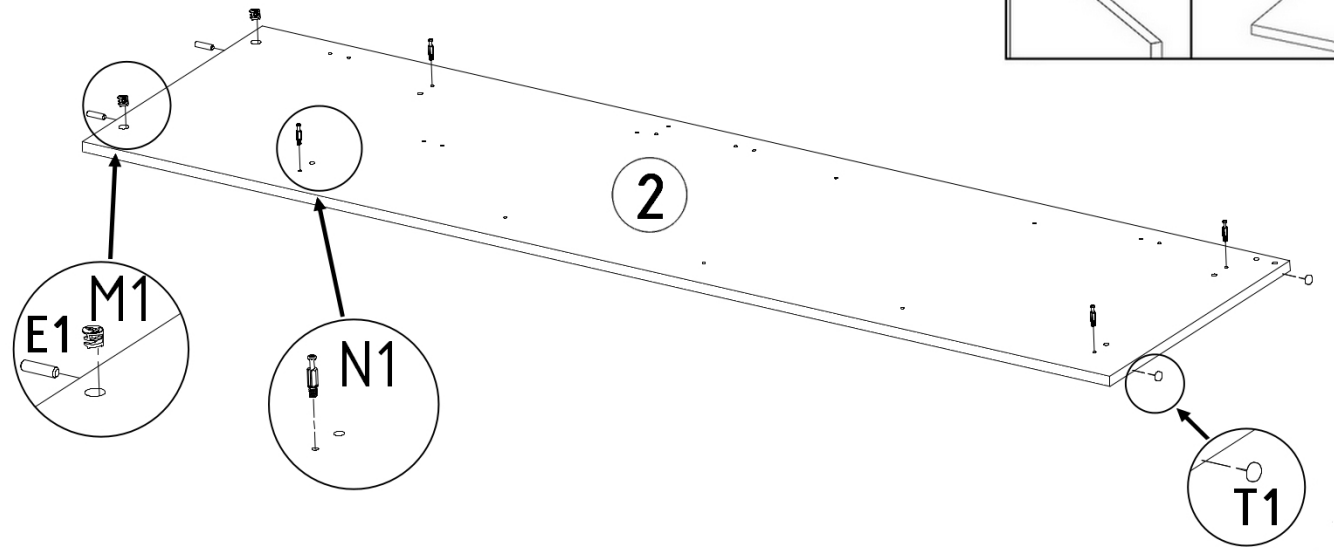
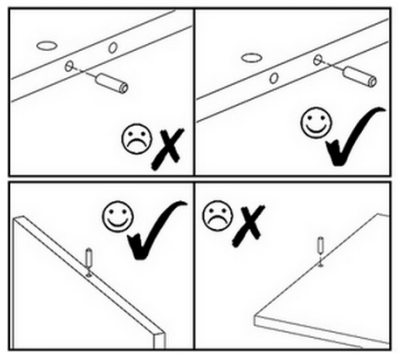

4

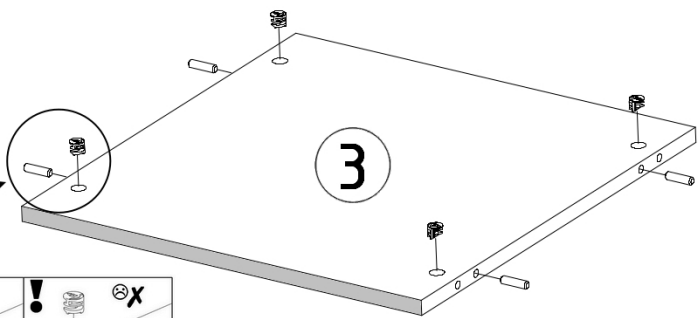
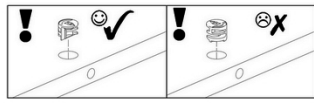
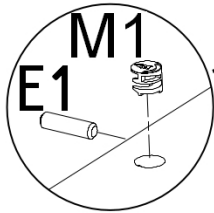
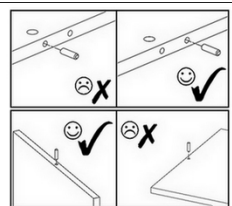
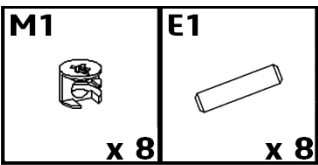

x 2

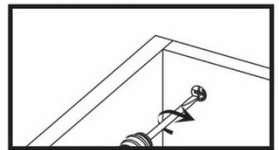
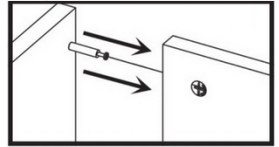
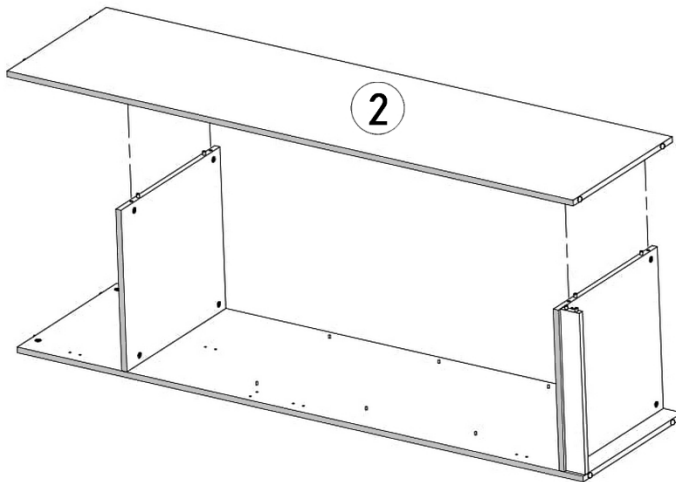
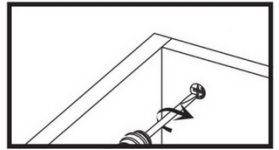
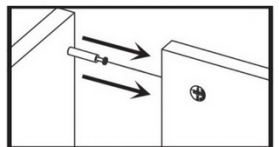
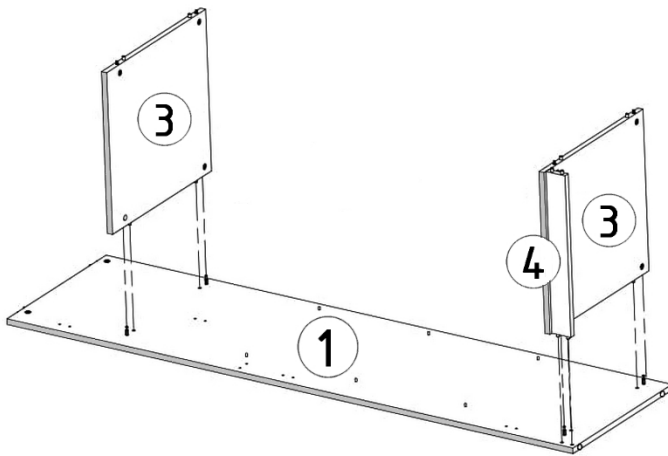
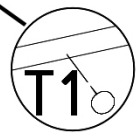
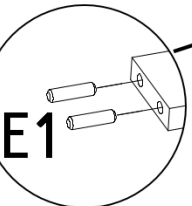
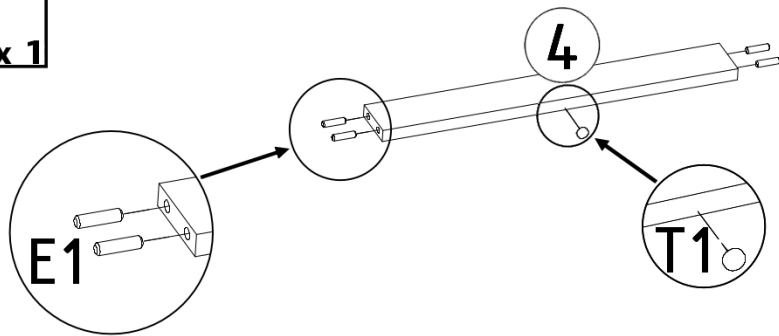
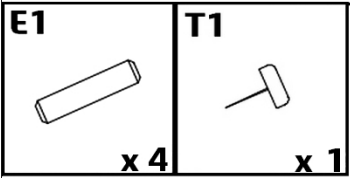

5

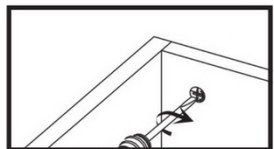
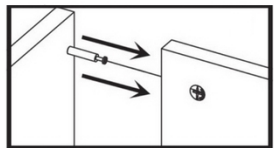
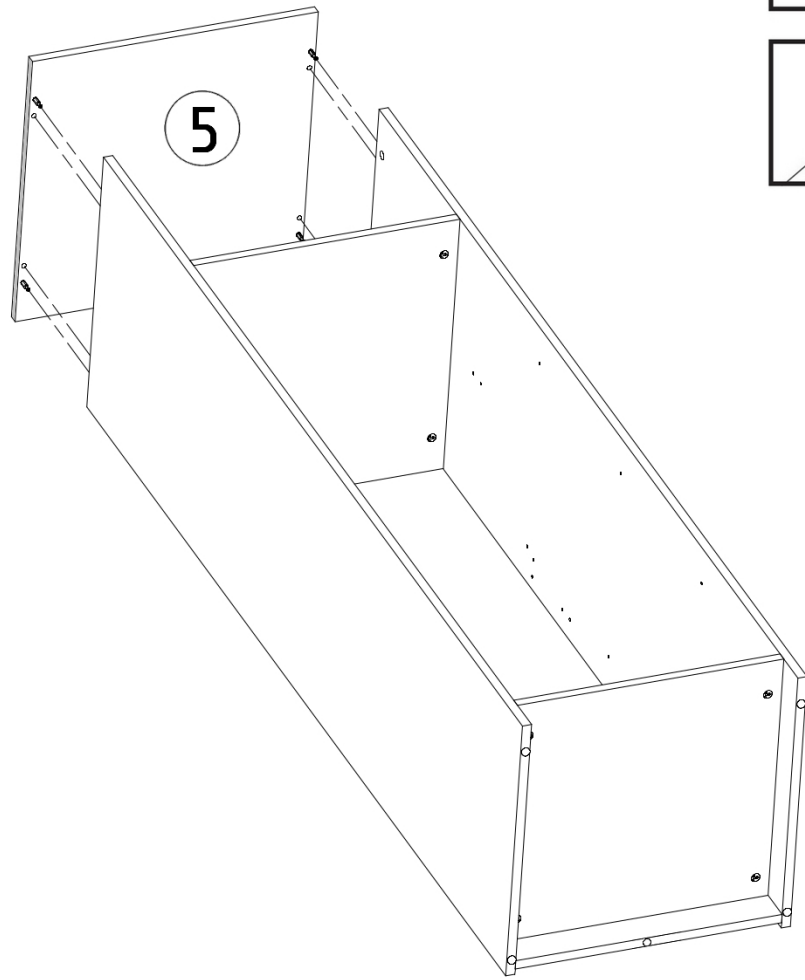
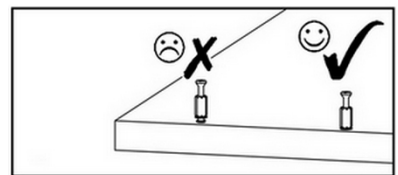
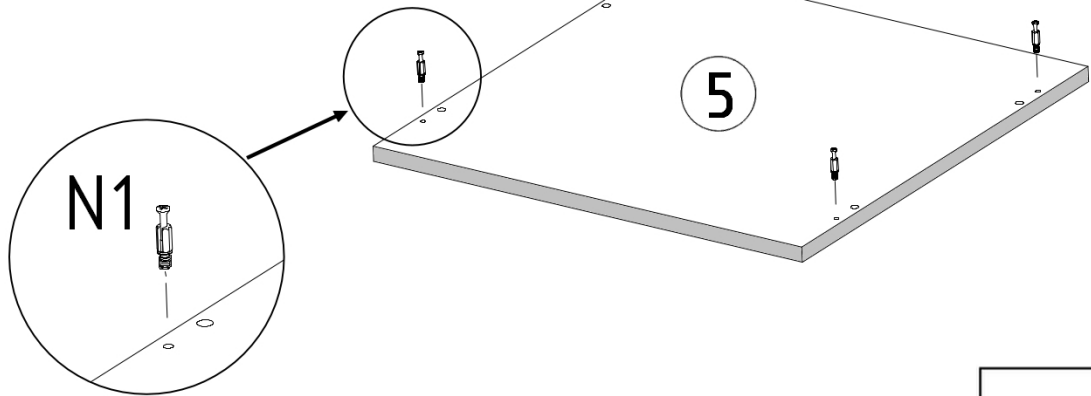
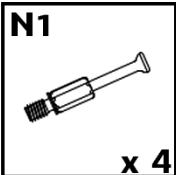

6

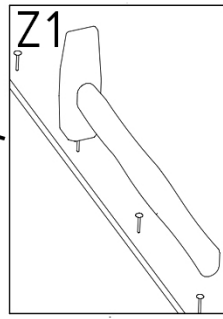
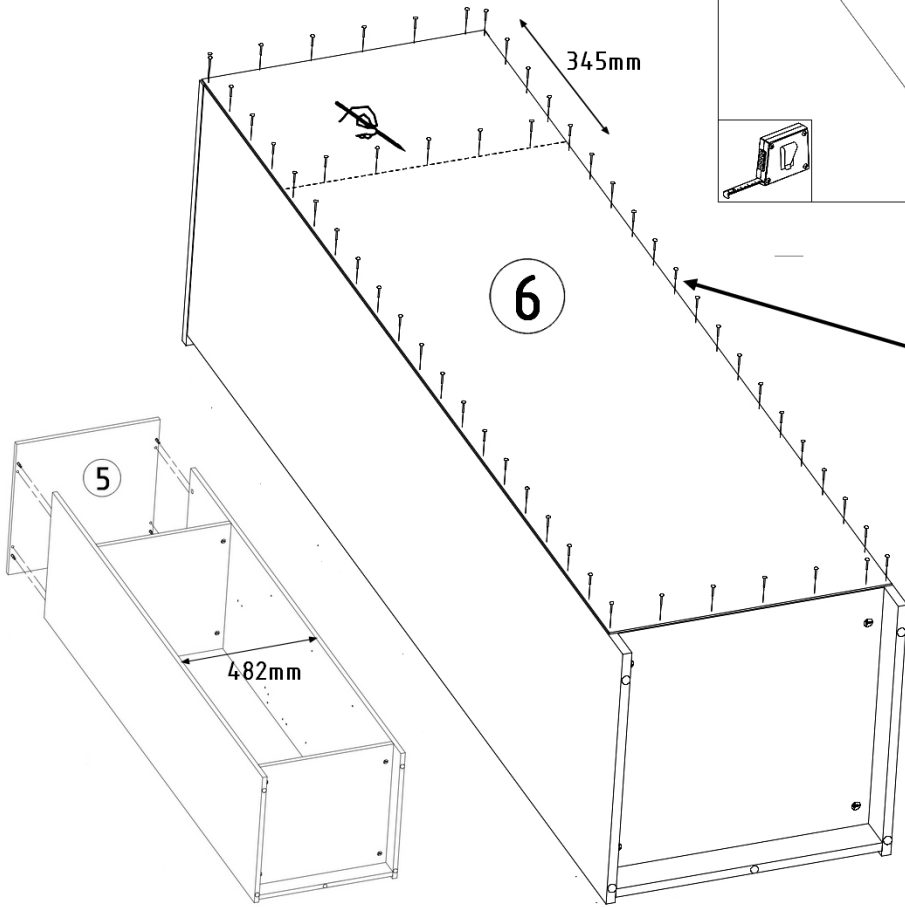
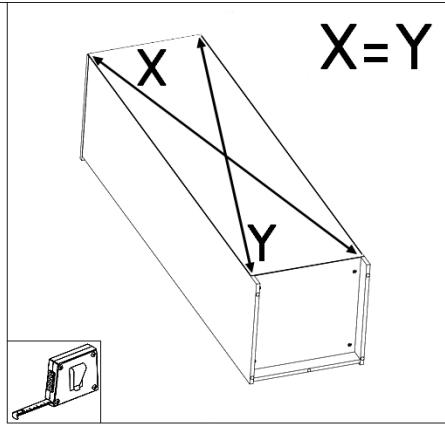
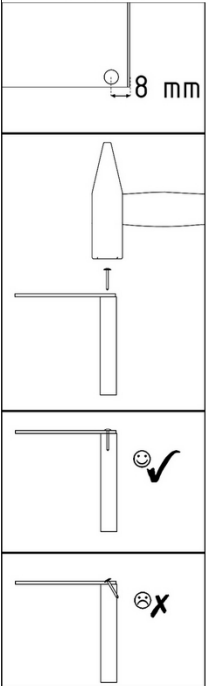

Z1
x 80



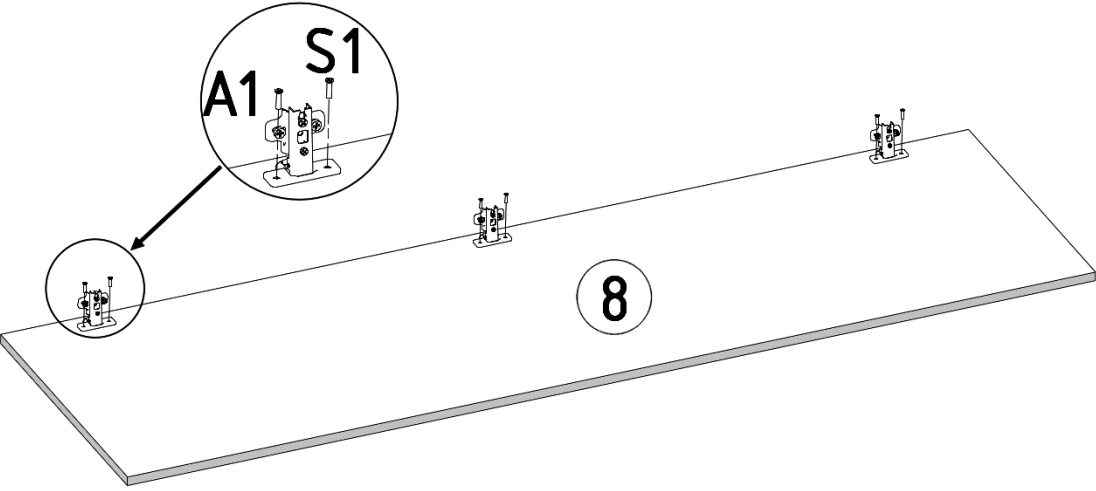

S1
x 6

A1
x 3

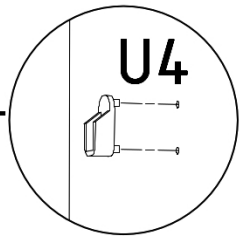
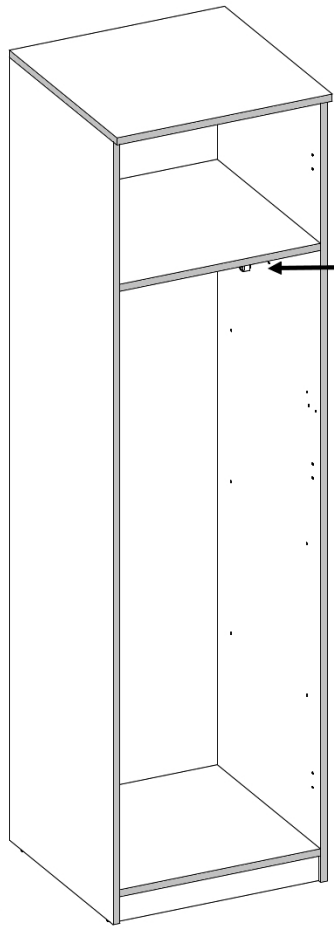
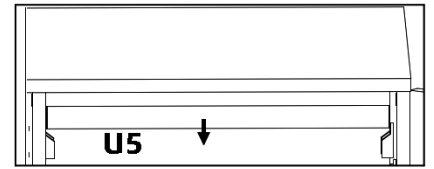

U4  x 2	U5  x 1
---	---



K7  x 12

