

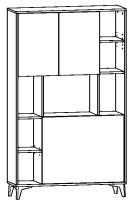











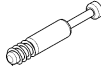

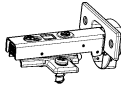
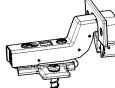

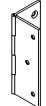
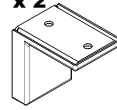
MEGAN 2

L-105 H-175 D-34/95



x 16  AKC00019	x 16  AKC00120	x 16  AKC00004	x 20  AKC00029	x 20  AKC00151	x 20  AKC00004
x 4  ZAW00025	x 2  ZAW00026	x 20  AKC00023	x 1  NOG00031	x 2  ZAW00014	x 2  AKC00066
x 60  AKC00018	x 24  3,5x16 AKC00026	x 24  4x25 AKC00026	x 4  AKC00031	x 1  AKC00017	x 2 N-120  MEC00453
x 4  NOG00041					



⌚ 60 min

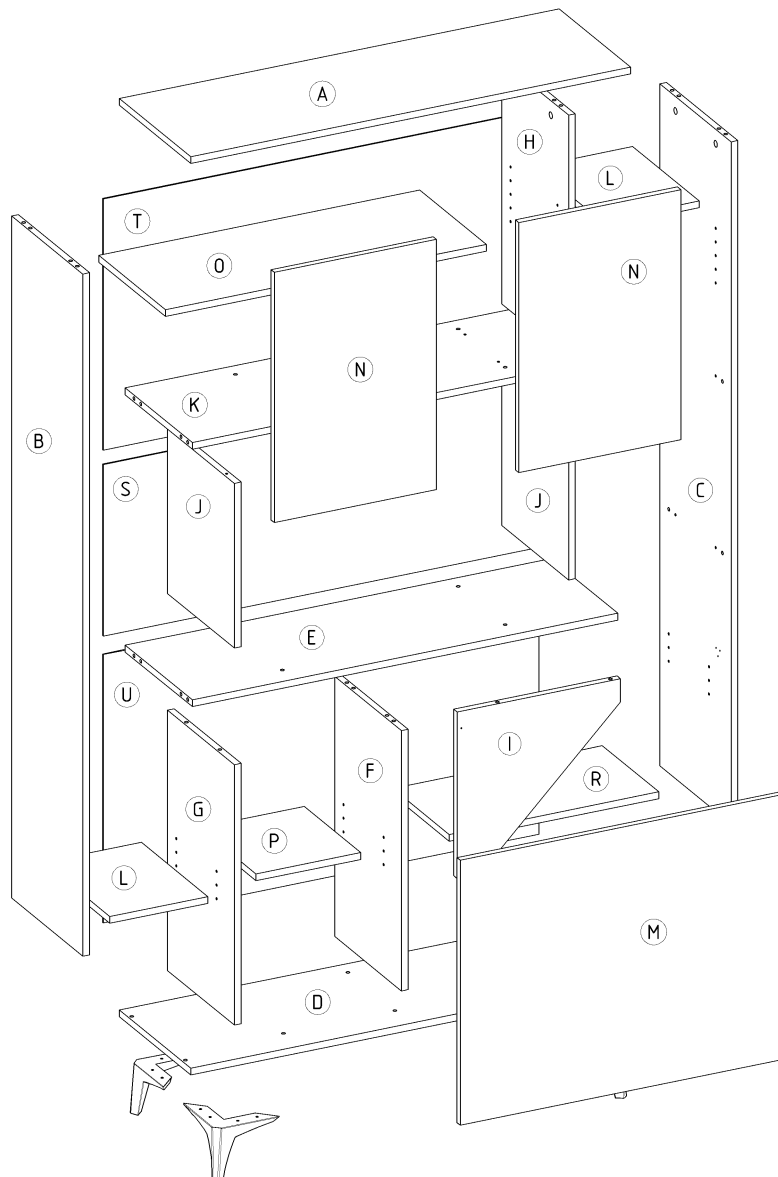

1

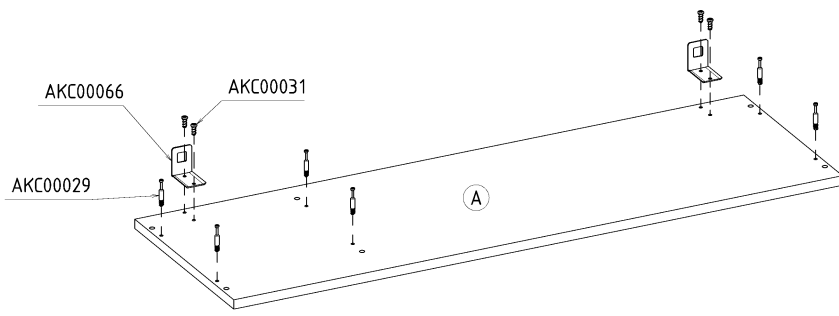

2

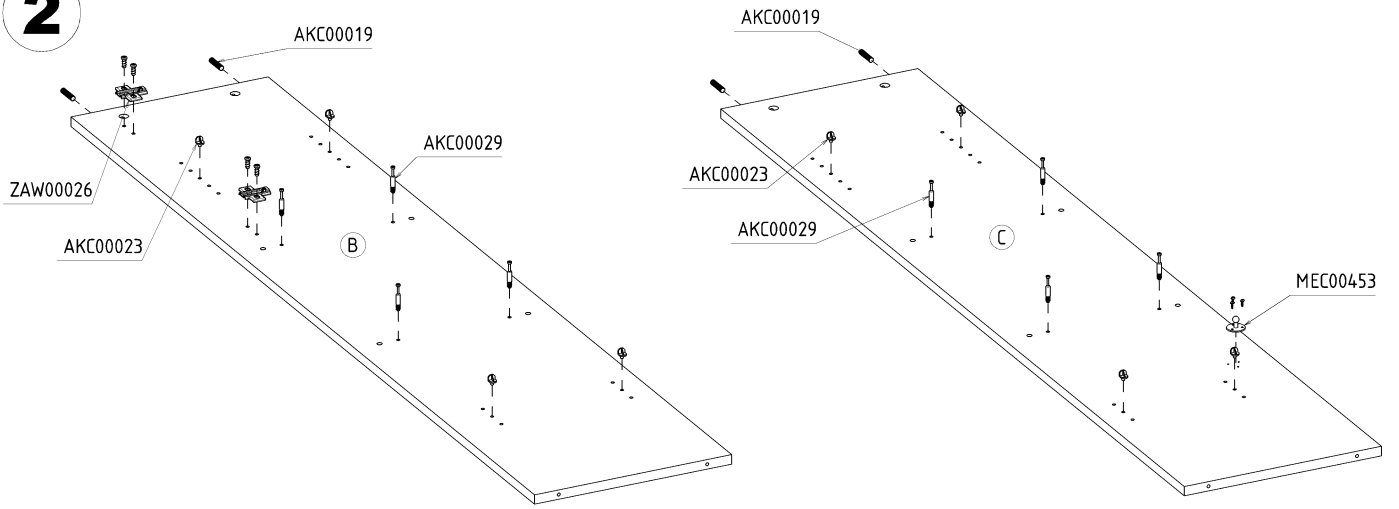

3

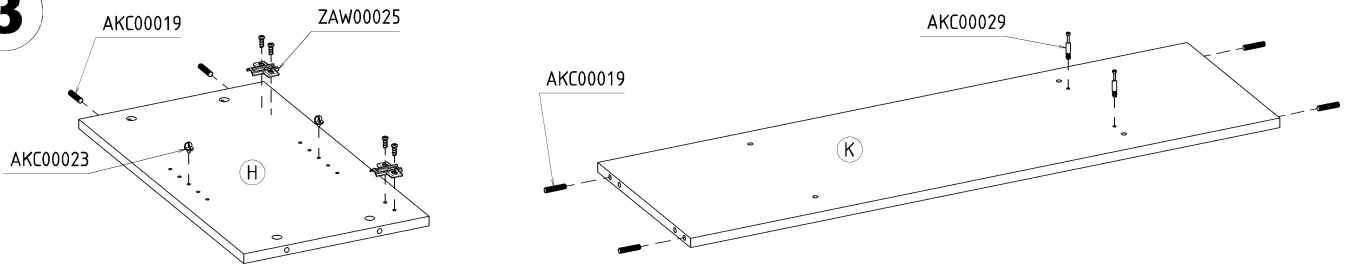

4

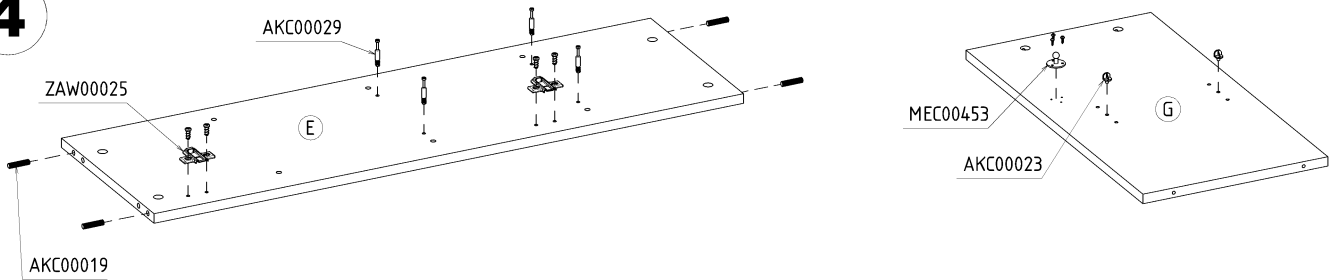

5

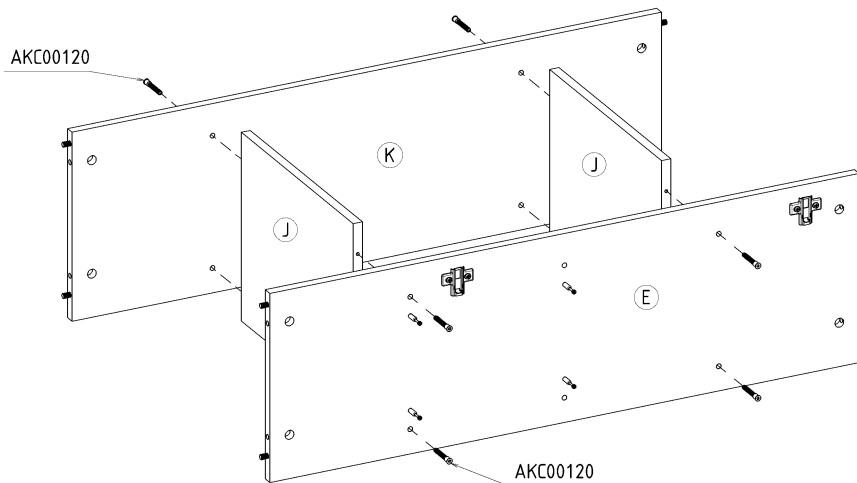

6

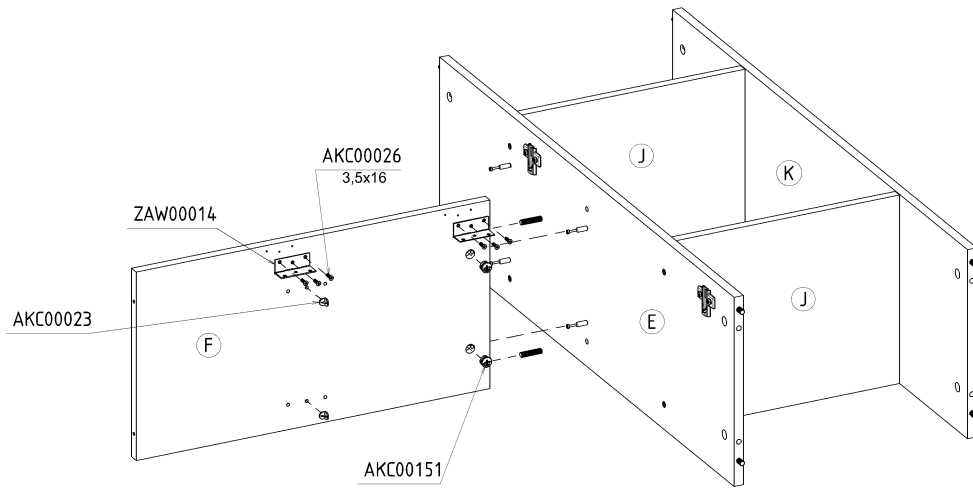

7

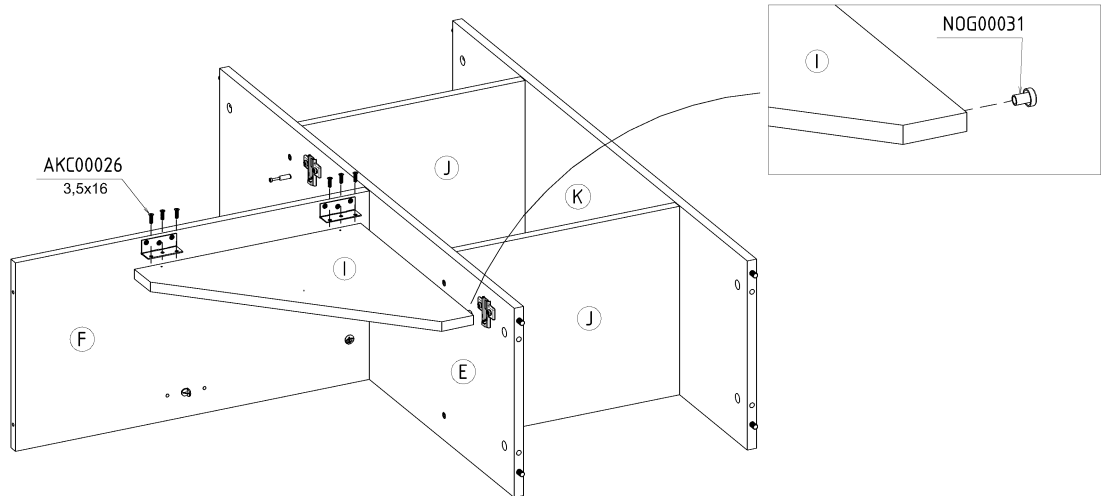

8

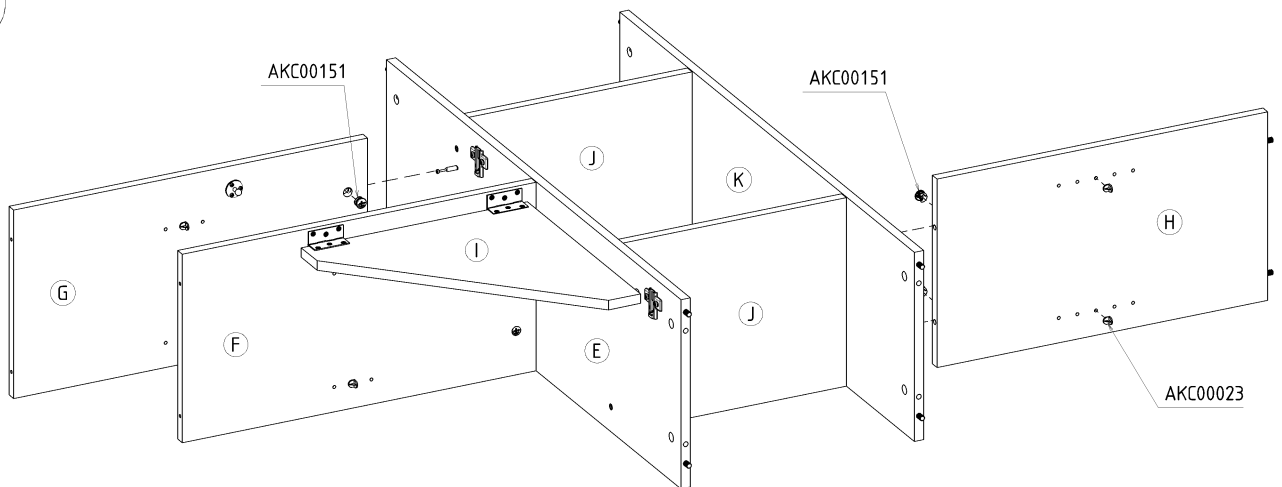

9

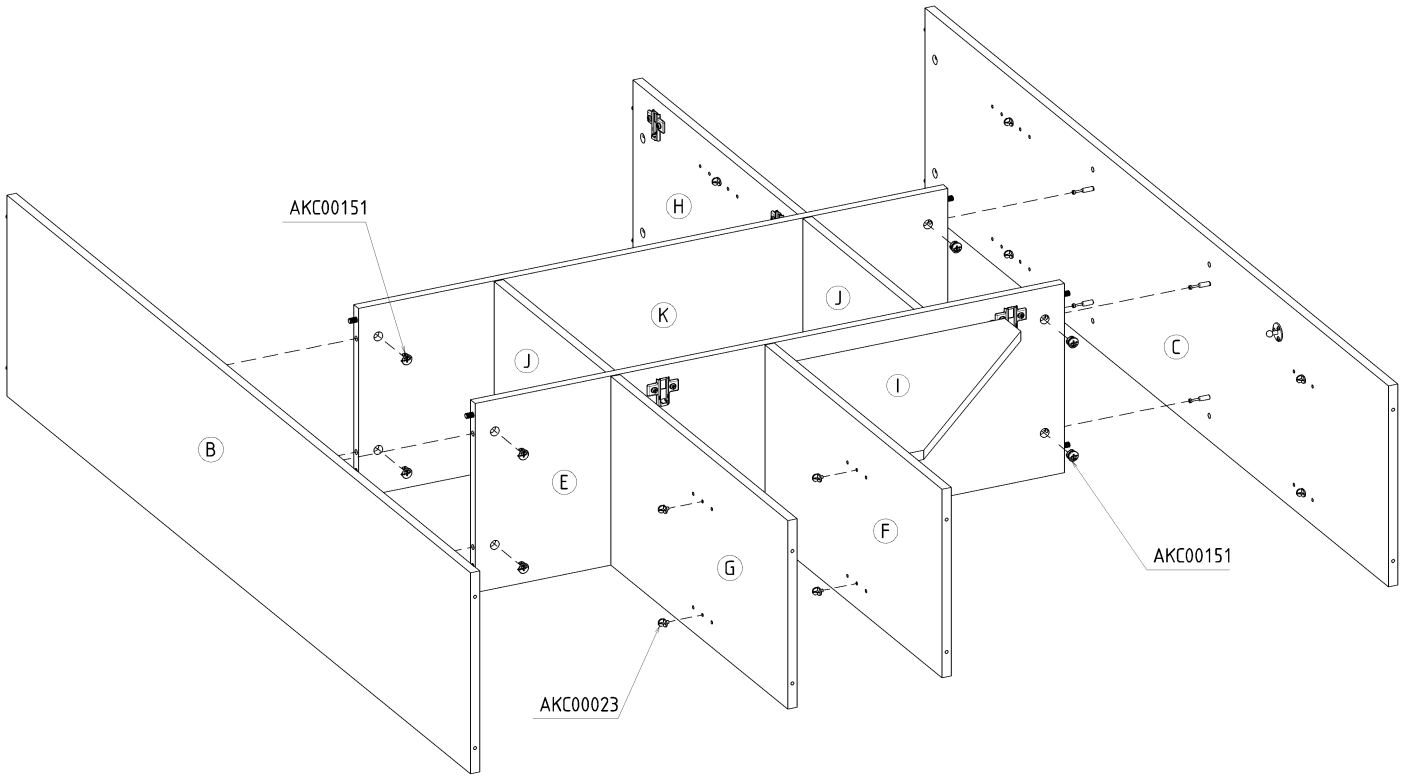

10

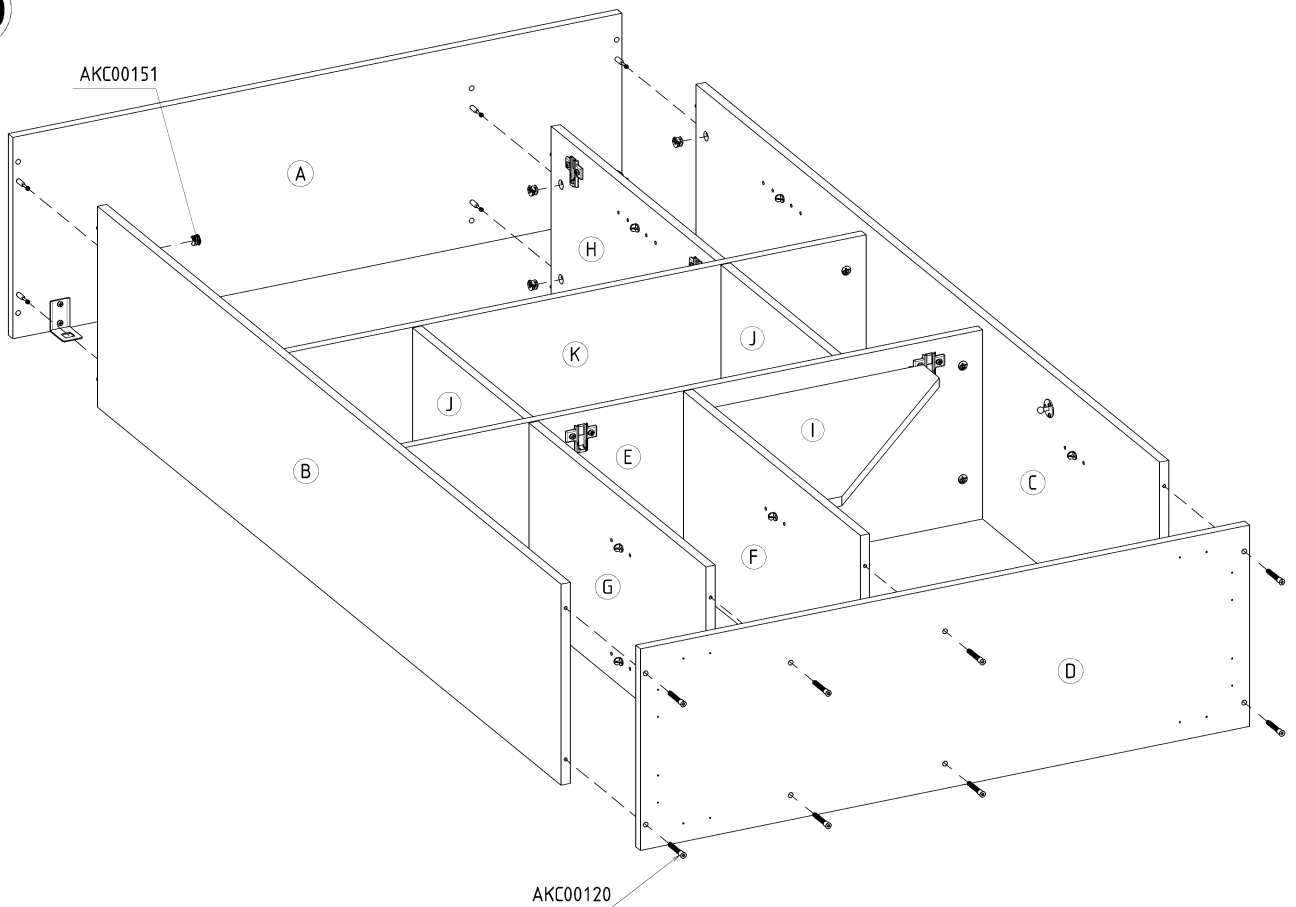

11

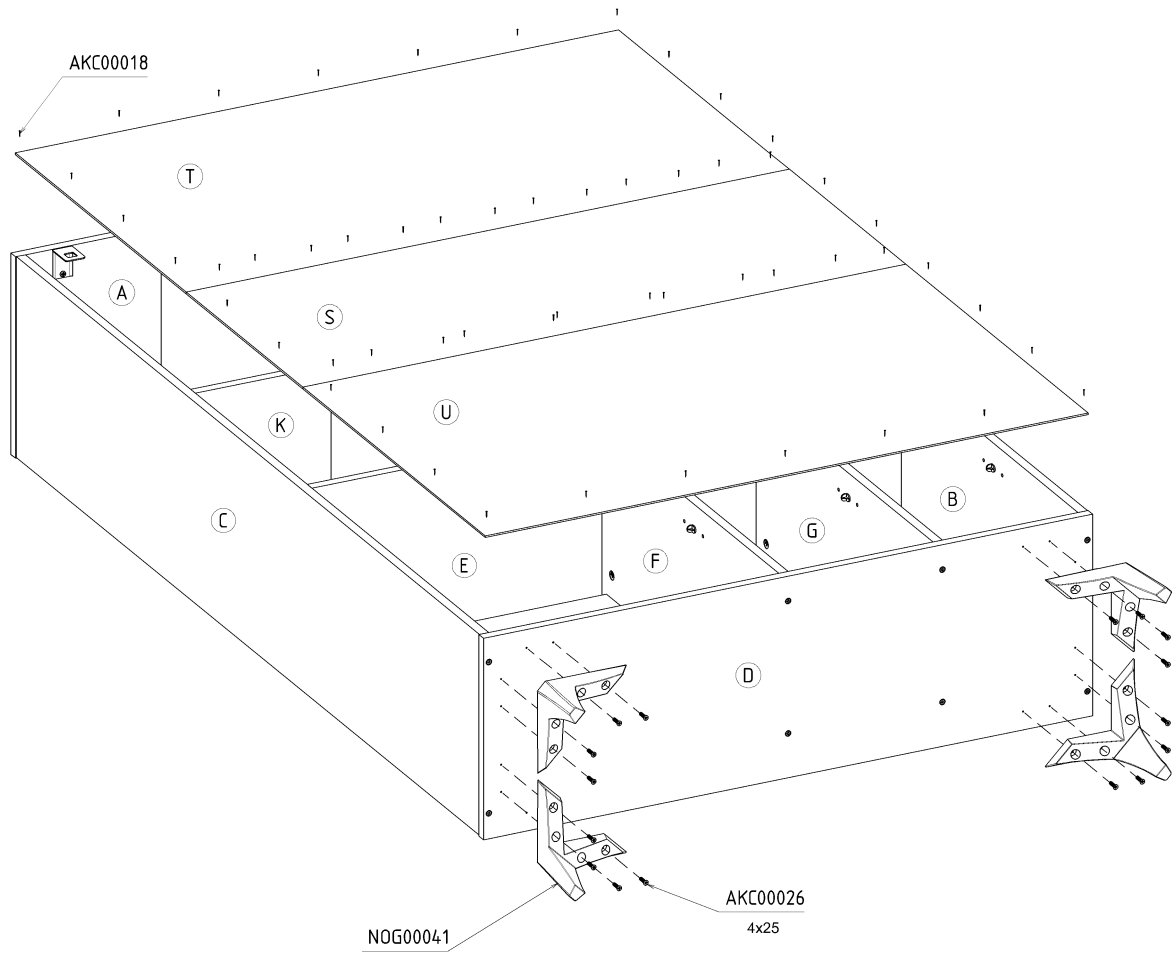

12

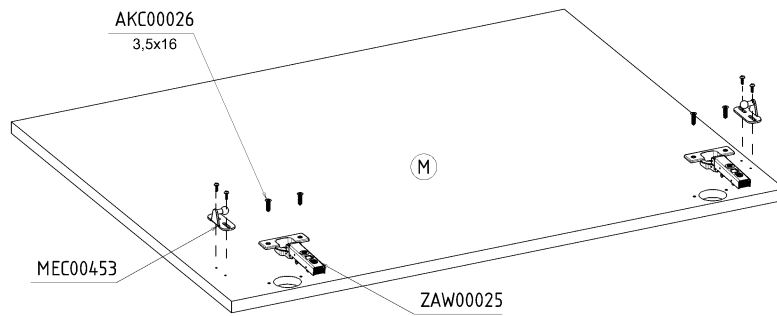

13

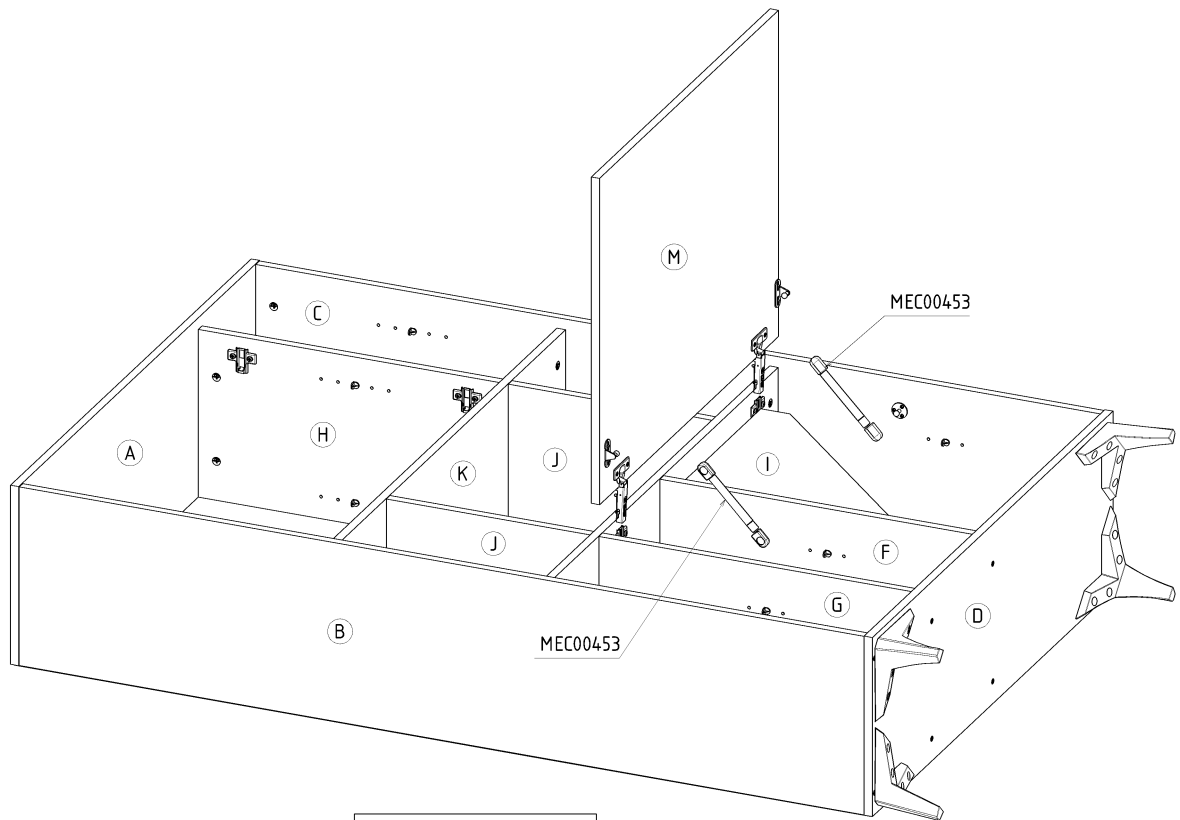

14

