

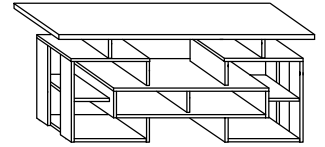

RIO-13 ŁAWA W → 130 × 56 × 68

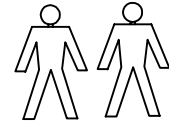

| | | | | | |
|----------|----------|----------|----------|---------|---------|
| x 49 | x 34 | x 34 | x 20 | x 8 | x 1 |
| (a) | (b) | (c) | (d) | (e) | (f) |

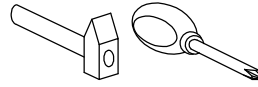

60 min



1 - FAZY MONTAŻU

A - OZNACZENIE ELEMENTÓW

a - OZNACZENIE AKCESORIÓW

1

| | |
|----------|----------|
| x 23 | x 18 |
| (a) | (b) |

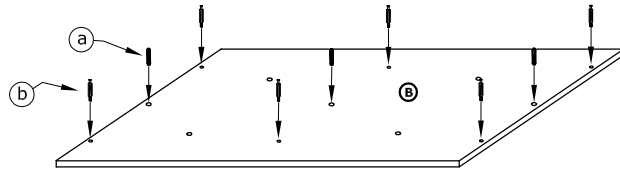
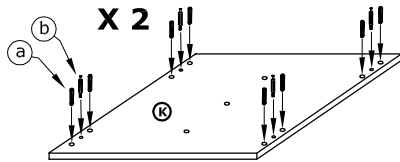
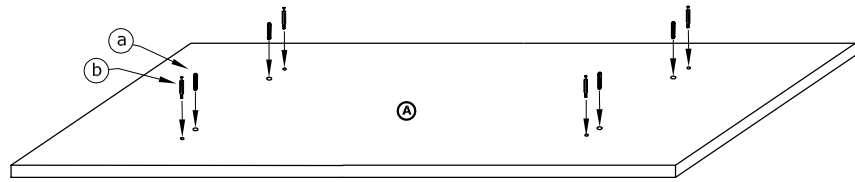

2

| | |
|----------|----------|
| x 26 | x 16 |
| (a) | (b) |
| x 8 | |
| (e) | |

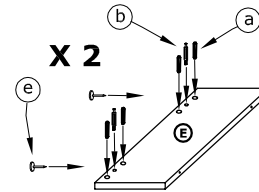
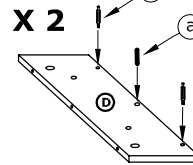
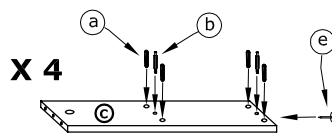

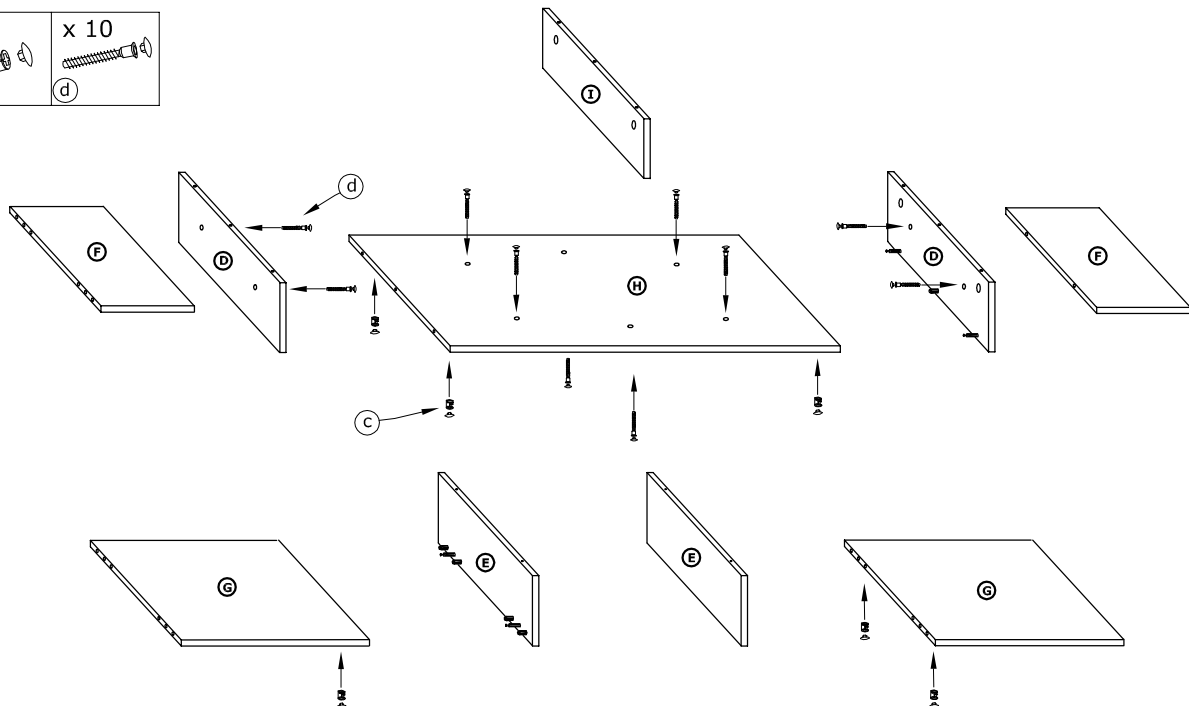

3

| | |
|---------|----------|
| x 8 | x 10 |
| (c) | (d) |



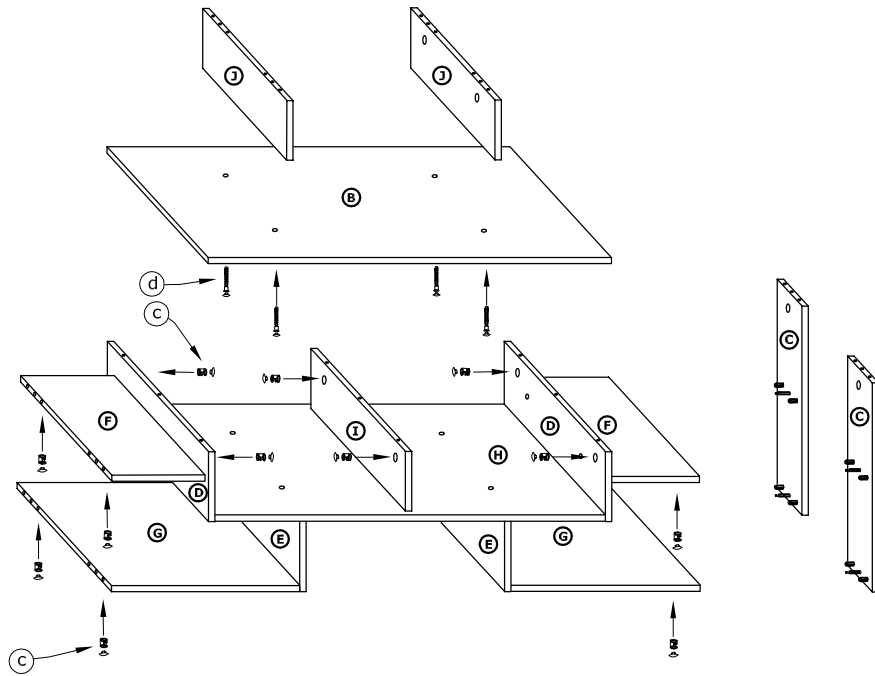
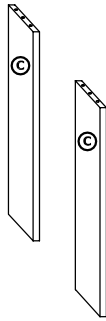

4

- x 14 
- x 4 



5

- x 8 
- x 6 

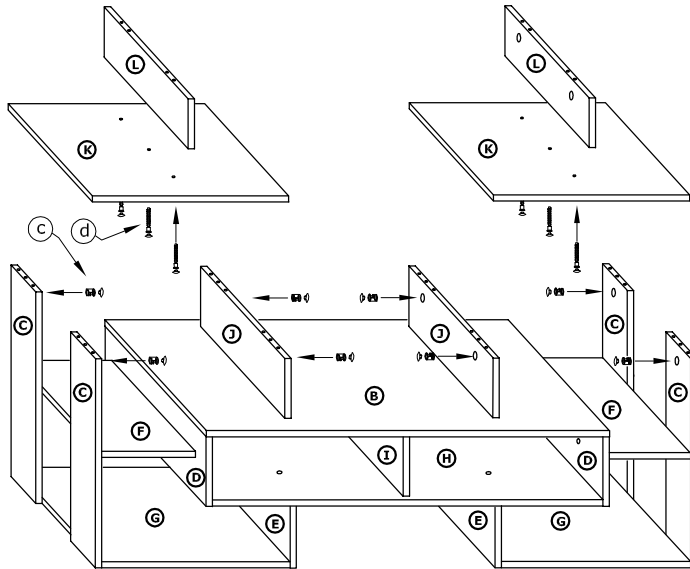

6

- x 4 