

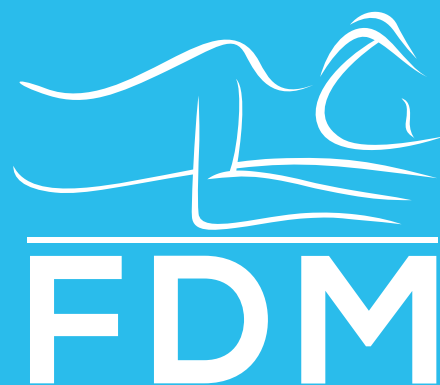

FDM

KIDS

MATTRESSES CATALOGUE



In the interest of
**HEALTH
 OF YOUR CHILD**
 the production process
 uses the technology of gluing mattresses

HOTMELT

WHY DID WE CHOOSE IT?

- it does not involve solvents
- it does not involve harmful volatiles and water
- it is 100% ecological
- it is fragrance-free



FDM company specializes in production and sales of mattresses. Thanks to our team efforts our offer is regularly updated with new models of mattresses, our technologies are constantly developed and gradually introduced to our latest products. Our offer also includes wide range of covers.

One of the most important objectives of our company is to provide high-quality budget products. Every day our teams attempt to adjust the offered products to the needs of our Customers. We keep an eye on the mattress market. Thanks to the wide range of products we can guarantee that each Customer will find a mattress that will satisfy their needs and meet their demands.

Our mattresses feature high-quality materials used in the production process as well as excellent execution technique. Our offer includes the following types of mattresses: foam, bonnell, pocket, multipocket and latex mattress whose decks are enhanced depending on individual needs of the Customer.

TABLE OF CONTENTS

 **ADRIANO** p. 4
Foam mattresses

 **ALBA** p. 5
Bonnell mattresses

 **BABY CARE** p. 6
Foam mattresses

 **BABY CLASSIC** p. 8
Foam mattresses

 **BABY COCO** p. 9
Foam mattresses

 **BEST SELLER**
BABY COMFORT p. 11
Foam mattresses

 **BABY NATURAL** p. 12
Bonnell mattresses

 **BAMBINO** p. 13
Bonnell mattresses

 **BITONTO** p. 14
Foam mattresses

 **BRESSO** p. 15
Foam mattresses

 **CORATO** p. 17
Foam mattresses

 **FAMILY kids** p. 18
Pocket mattresses

 **IRIS** p. 19
Bonnell mattresses

 **LUGO** p. 20
Foam mattresses

 **LUIGI** p. 21
Foam mattresses

 **MAYA** p. 22
Pocket mattresses

 **BEST SELLER**
MILANO p. 23
Pocket mattresses

 **MILETO** p. 24
Foam mattresses

 **MONZA** p. 25
Foam mattresses

 **PADWA** p. 27
Foam mattresses

 **PARMA** p. 28
Foam mattresses

 **PIKOLO** p. 29
Foam mattresses

 **ROVIGO** p. 30
Foam mattresses

 **SIENA** p. 31
Bonnell mattresses

 **SORRENTO** p. 32
Foam mattresses

 **TERAMO** p. 34
Foam mattresses

 **TORINO** p. 35
Pocket mattresses

 **TREVISO** p. 36
Pocket mattresses

 **TORO kids** p. 37
Latex mattresses

 **BEST SELLER**
UDINE kids p. 38
Latex mattresses

 **VASTO** p. 39
Pocket mattresses

 **WATERPROOF PROTECTOR** p. 40
Accessories

 **COVERS** p. 41
Accessories

EXPLANATION OF SYMBOLS



FOAM MATTRESSES

Foam mattresses are based on reinforced polyurethane foam T25. It is very light, and precisely adjusts to the body shape. The foam does not deform which guarantees prolonged lifetime of the mattress and sleeping comfort. It is recommended even for infants. Our offer includes different models of foam mattresses which in combination with additional materials demonstrate medicinal properties and wide range of benefits.



POCKET MATTRESSES

The base of pocket mattresses is a form which consists of springs made in double hardening technology. It improves their lifetime up to 30 years. Each of them has a separate material pocket. Thus, each spring works independently. The pocket deck is made of a wire with different diameters, thus providing different hardness grades for particular zones. Their composition is adjusted to the body shape of the user, providing a very high comfort of sleeping and relaxation. Our mattresses have 7 hardness zones and demonstrate high point elasticity. They are recommended for older children and teenagers.

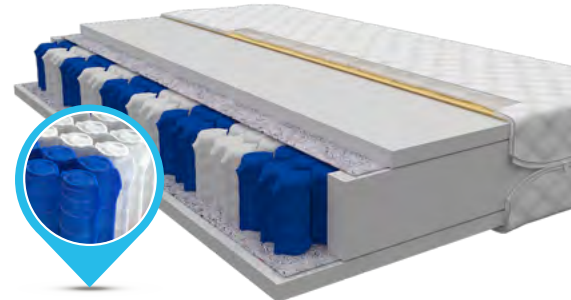

BONNELL MATTRESSES

Each of our bonnell mattresses consists of ca. 130 high-quality aligned springs /m2 combined with each other with a spiral wire. They feature high-flexibility and provide proper air circulation inside the mattress. Models with bonnell springs are suitable for different weight ranges, so they are great for older children and teenagers.



LATEX MATTRESSES

Base of these mattresses is the high-quality latex foam, made of the composition of natural and synthetic rubber. It is made of a very durable material and perfectly adjusts to the body shape. It is suitable for allergy sufferers as no dust or acarus is accumulated. It has porous and "breathing" surface which provides proper hygiene and excellent air circulation inside the mattress.

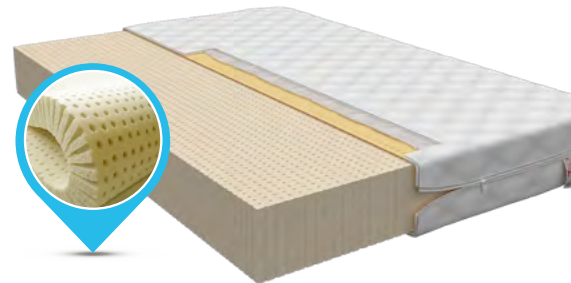

Thermoplastic VISCO foam

It has a body memory function. Special structure of this material triggers its reaction to temperature and pressure. The layer takes the exact posture shape of the person who lies on it. This state remains for several dozen seconds.



Moulded HR foam

The 7-zone moulded HR foam demonstrates higher flexibility which increases the comfort of use and prolongs its lifetime.



Coconut deck

Natural coconut fibers binned during the production process, create a stiffened, airy plate which reinforces the mattress and forms a perfect barrier from mould and acarus.



Natural buckwheat hull

It is closed in quilted, extra selected zones. It provides proper air circulation and does not warm up, thus preventing from excessive sweating.



Upholstery deck

It increases strength of the mattress, separates the spring deck from the foam deck.



Climate regulating fiber

Fluffy non-woven synthetic fabric which improves air circulation and warms up the mattress.



Sheep wool

It warms up, helps maintain constant body temperature and our skin can breathe at the same time.



HIGH-CLASS COVER FOR FREE

to each mattress from our PREMIUM offer



PREMIUM Cover

- resistant to dirt
- made of first grade hypoallergenic materials.
- provides good ventilation
- resistant to stretch
- to be washed in 30°C



ADRIANO

Foam Mattresses

↑ 11 cm

Premium quilted cover

7-zone highly-flexible moulded HR foam

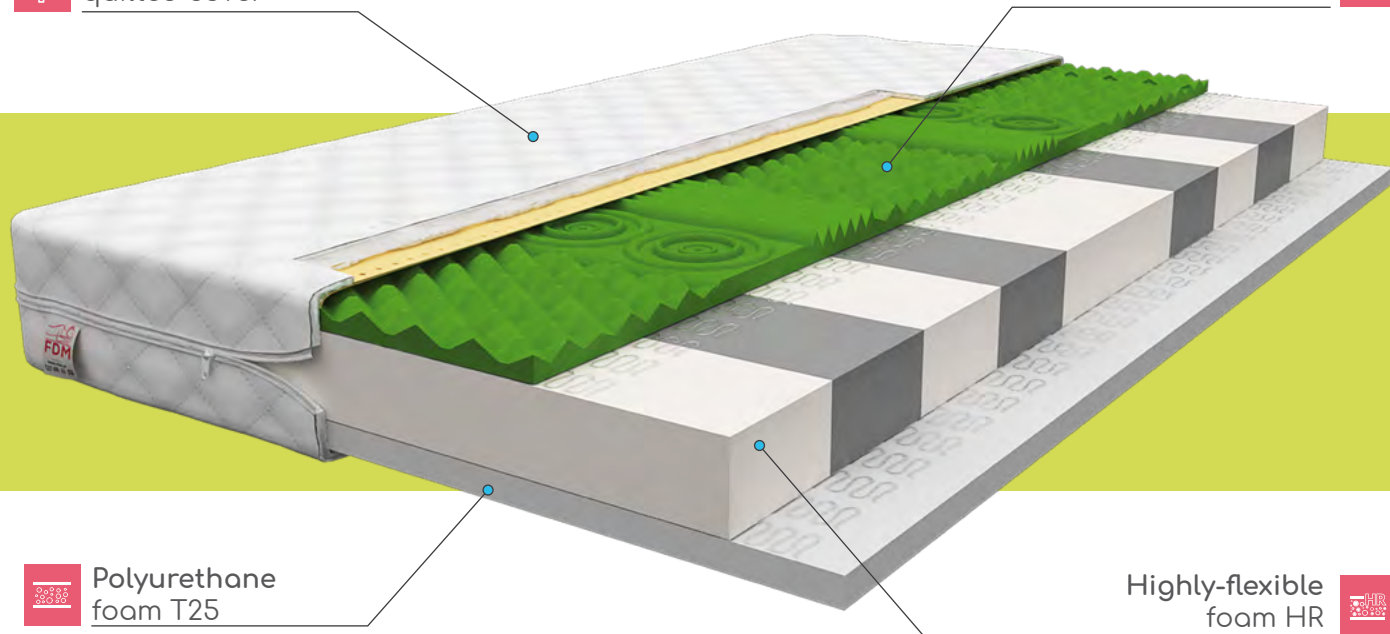

Polyurethane foam T25

Highly-flexible foam HR

ALBA

Bonnell Mattresses

↑ 13 cm

Premium quilted cover

7-zone highly-flexible moulded HR foam

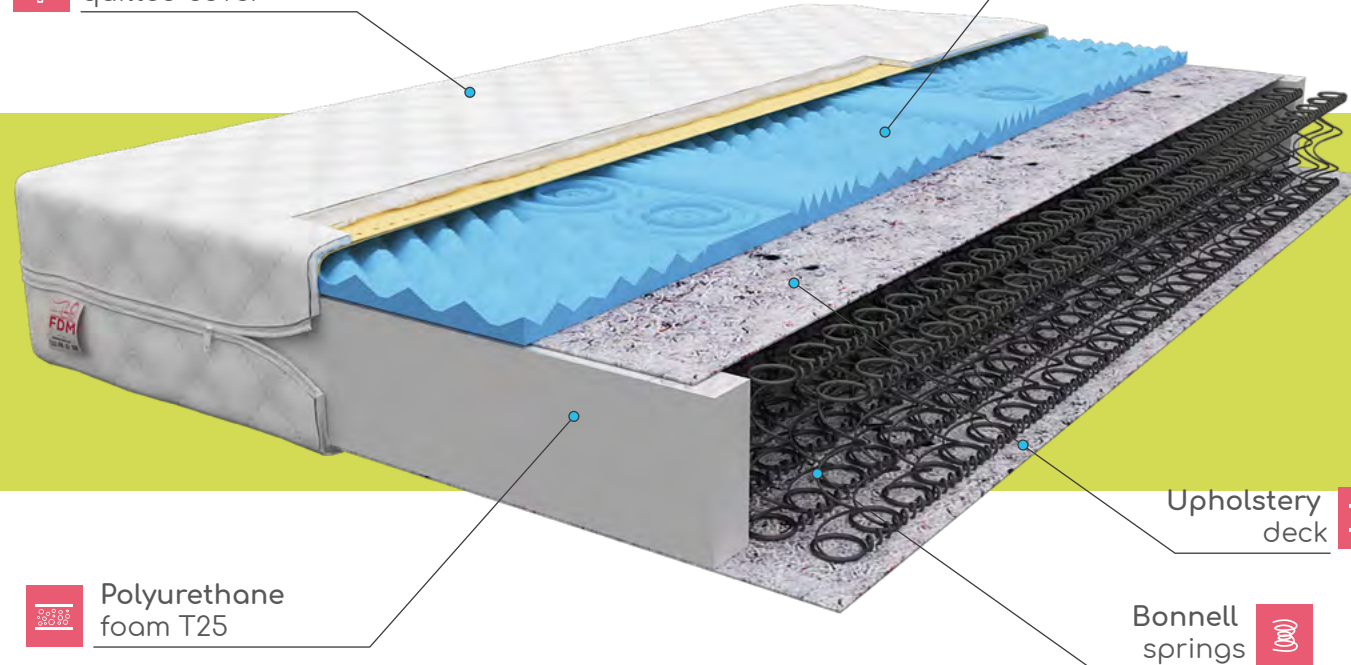

Polyurethane foam T25

Upholstery deck

Bonnell springs

About the mattress

Adriano model is a combination of three types of foams selected by our experts to provide a child with the highest comfort of sleep. The layers of the mattress stick to each other and provide support for each body part and the spine. Additional benefit of this model is long lasting durability.

Mattress structure

Moulded HR foam	2 cm
Highly-flexible foam HR	6 cm
Polyurethane foam	2 cm

What distinguishes this mattress from the others?



Moulded HR FOAM

Polyurethane FOAM T25

7-zone HR FOAM

About the mattress

Alba is a mattress based on a deck with bonnell springs, combined on one side, made of high-quality moulded HR foam. This model features high-elasticity of surface and proper support for the spine. HR foam increases the feeling of lightness by adjusting to the body shape.

Mattress structure

Moulded HR foam	2 cm
Upholstery deck	
Bonnell springs	10 cm
Upholstery deck	

What distinguishes this mattress from the others?

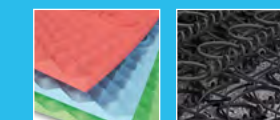

Moulded HR FOAM

Durable BONNELL SPRINGS

BABY CARE

Foam Mattresses

↑ 9 cm

Premium quilted cover

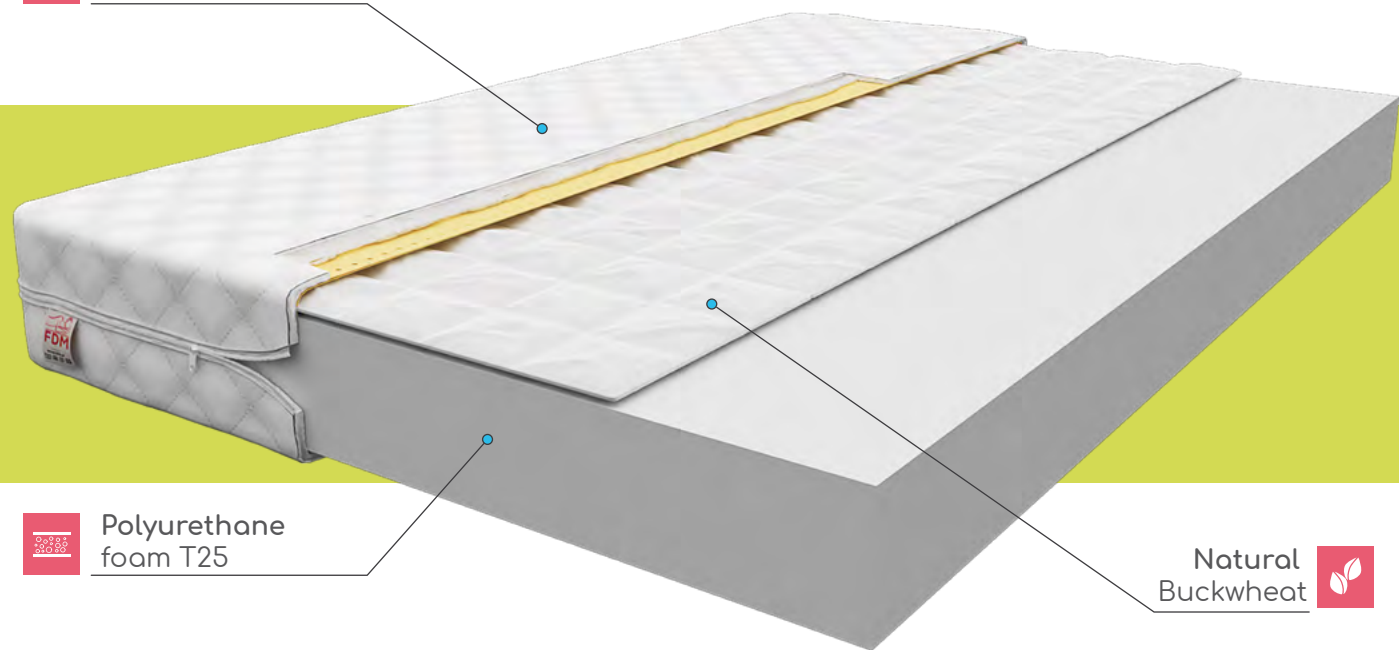

Polyurethane foam T25

Natural Buckwheat

About the mattress

Baby Care model is recommended for infants. Its hardness grade has been selected to ensure free movements even for infants. The layer of natural buckwheat hull demonstrates medicinal properties, prevents from bedsores and spinal malformations and treats the already existing ones.

Mattress structure

 Natural buckwheat	1 cm
 Polyurethane foam	7 cm

What distinguishes this mattress from the others?



Natural BUCKWHEAT



Polyurethane FOAM T25

Natural BUCKWHEAT

Selected models from our offer include decks made of natural buckwheat hull closed in quilted, extra selected zones. It demonstrates many medicinal properties, so it is recommended even for infants.

IT CONSISTS OF FABRICS

Tannins prevent from the formation of acarus and bacteria in the mattress as well as on the skin.

IT IS VERY FLEXIBLE

It adjusts to the body shape and does not collapse from the weight. It provides strong, stable support for the head and spine, it does not spring-back.

IT FEATURES ANTIALLERGIC PROPERTIES

It does not absorb dust, moisture, prevents from the formation of acarus and bacteria. The mattress is always dry, does not mould, and is not penetrated by parasites. Buckwheat provides natural air permeability which makes it useful in preventive treatment of many diseases.



BABY CLASSIC

Foam Mattresses

↑ 10 cm

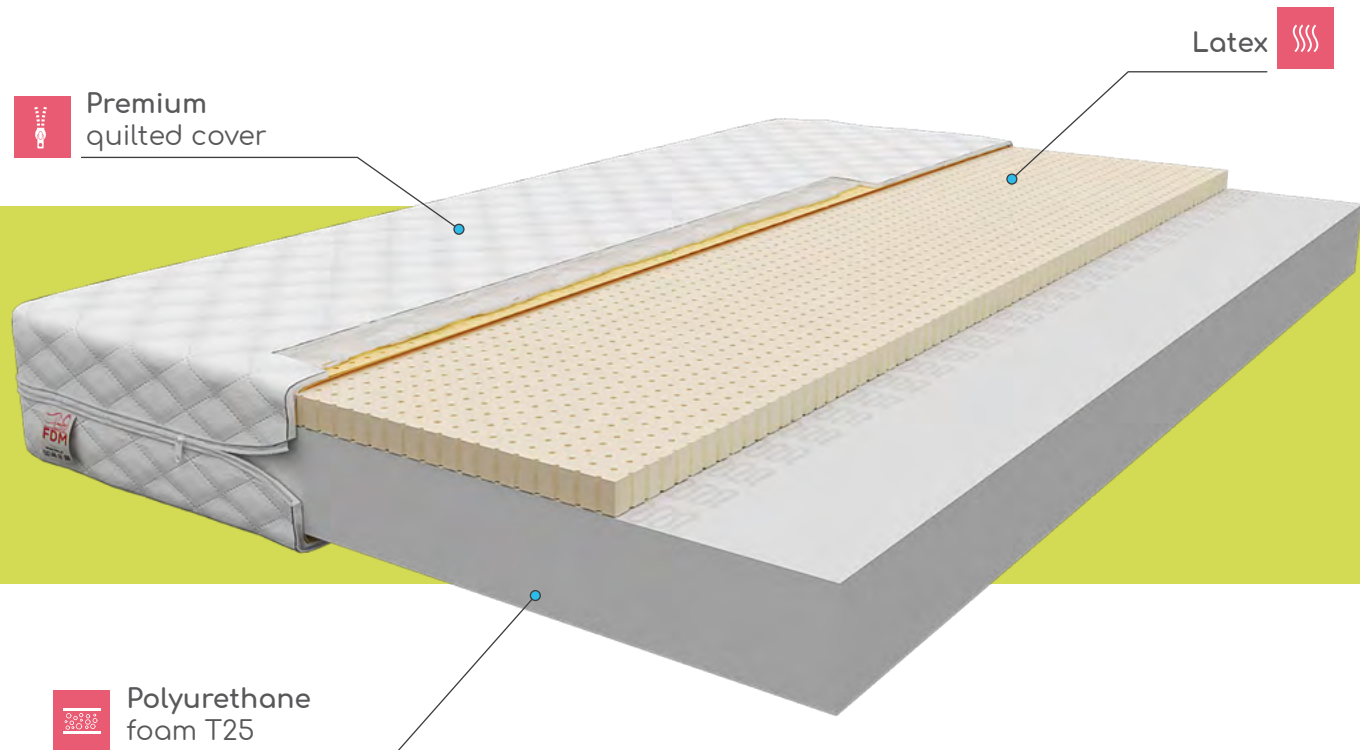

BABY COCO

Foam Mattresses

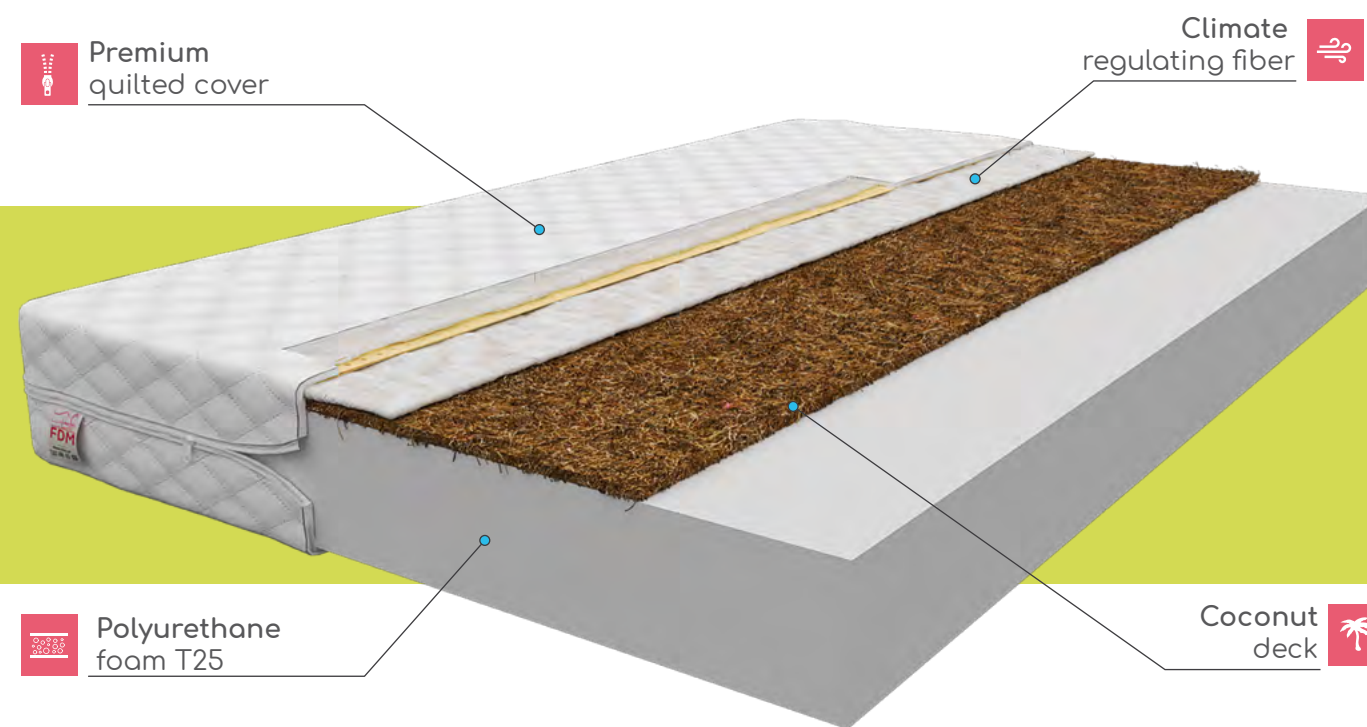

↑ 9 cm



About the mattress

Healthy sleep is the key factor supporting proper development of a child, so we created **Baby Classic** model which can be used by the youngest. In addition to the high-quality polyurethane foam T25, this model consists of latex which provides perfect ventilation and proper support for the spine.

Mattress structure

	Latex	2 cm
	Polyurethane foam	7 cm

What distinguishes this mattress from the others?





Polyurethane FOAM T25

Antiallergic LATEX

About the mattress

Baby Coco has been made of the highest-quality polyurethane T25 foam, which provides proper position of the body while sleeping or relaxing. In addition, it has been equipped with coconut mat which hardens the mattress by maintaining its flexibility at the same time. It is recommended even for infants.

Mattress structure

	Climate regulating Fiber	1 cm
	Coconut deck	
	Polyurethane foam	7 cm

In this model, a coconut layer was used. It is 100% ecological, obtained from coconut shell.



COCO



Perfect ventilation and healthy sleep.

A material suitable for
ALLERGY SUFFERERS

- It prevents from the formation of mould and acarus
- Better ventilation of the mattress
- It features antiallergic properties



BABY COMFORT

Foam Mattresses

↑ 10 cm

Premium quilted cover

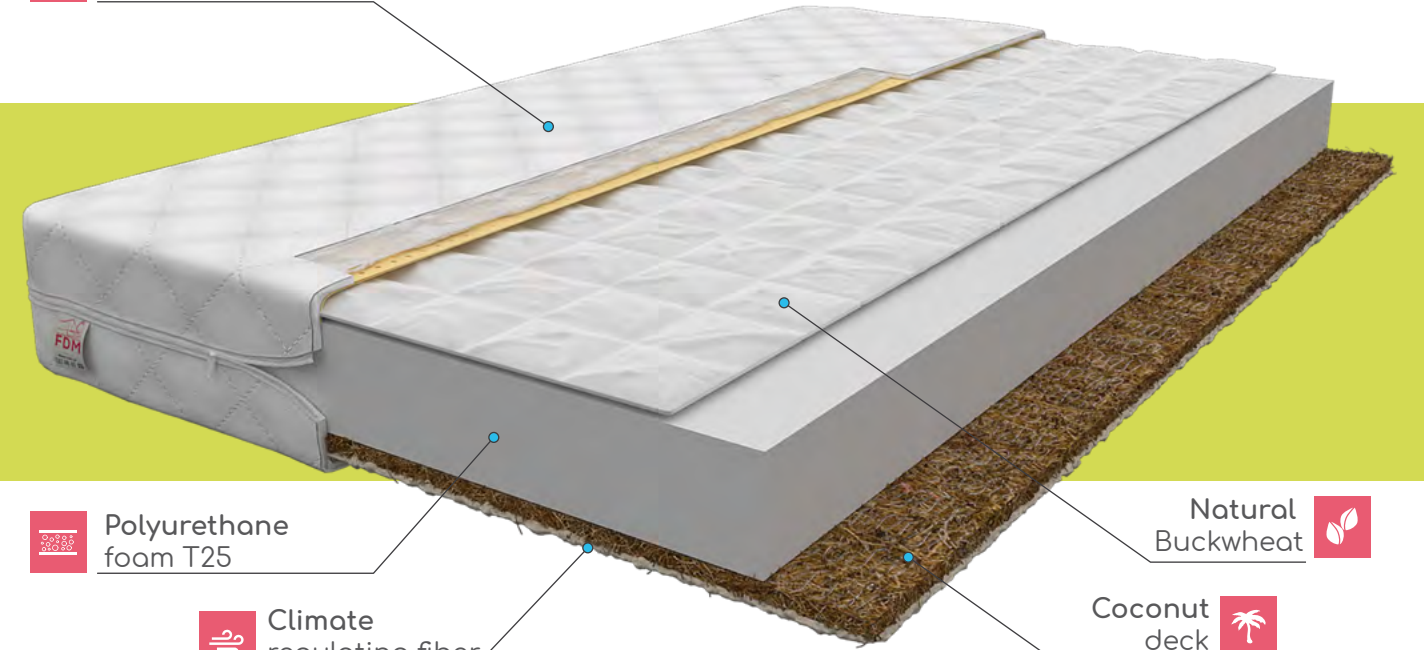

Polyurethane foam T25

Climate regulating fiber

Natural Buckwheat

Coconut deck

About the mattress

Baby Comfort has been developed specifically for the youngest. It is based of high-grade polyurethane foam T25, enriched with coconut and buckwheat mat. Thanks to the combination of these layers the mattress demonstrates medicinal properties: it provides proper support for the spine, does not form any bedsores and demonstrates antibacterial properties.

Mattress structure

	Natural Buckwheat	1 cm
	Polyurethane foam	7 cm
	Coconut deck	1 cm
	Climate regulating fiber	

What distinguishes this mattress from the others?



Natural BUCKWHEAT



Polyurethane FOAM T25



Ecological COCO

BABY NATURAL

Bonnell Mattresses

↑ 14 cm

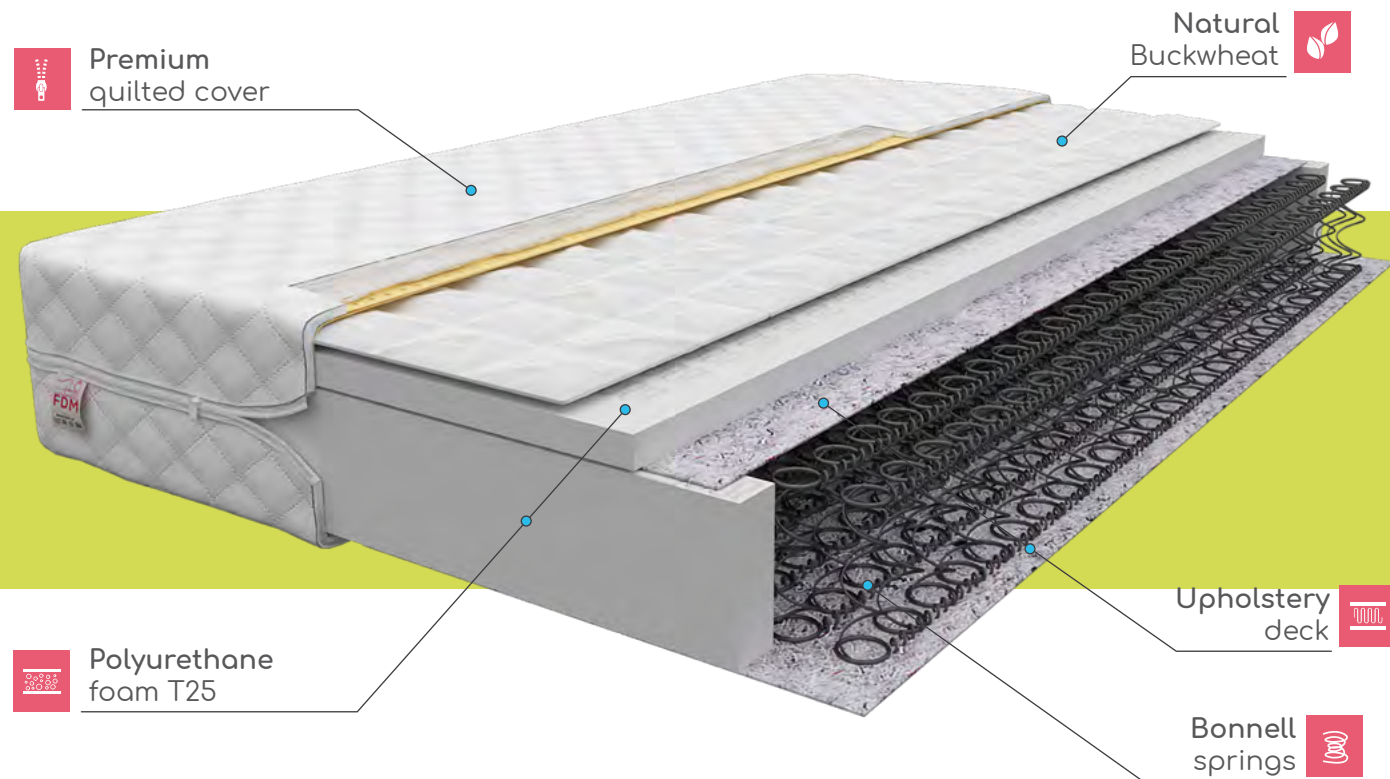

BAMBINO

Bonnell Mattresses

↑ 15 cm

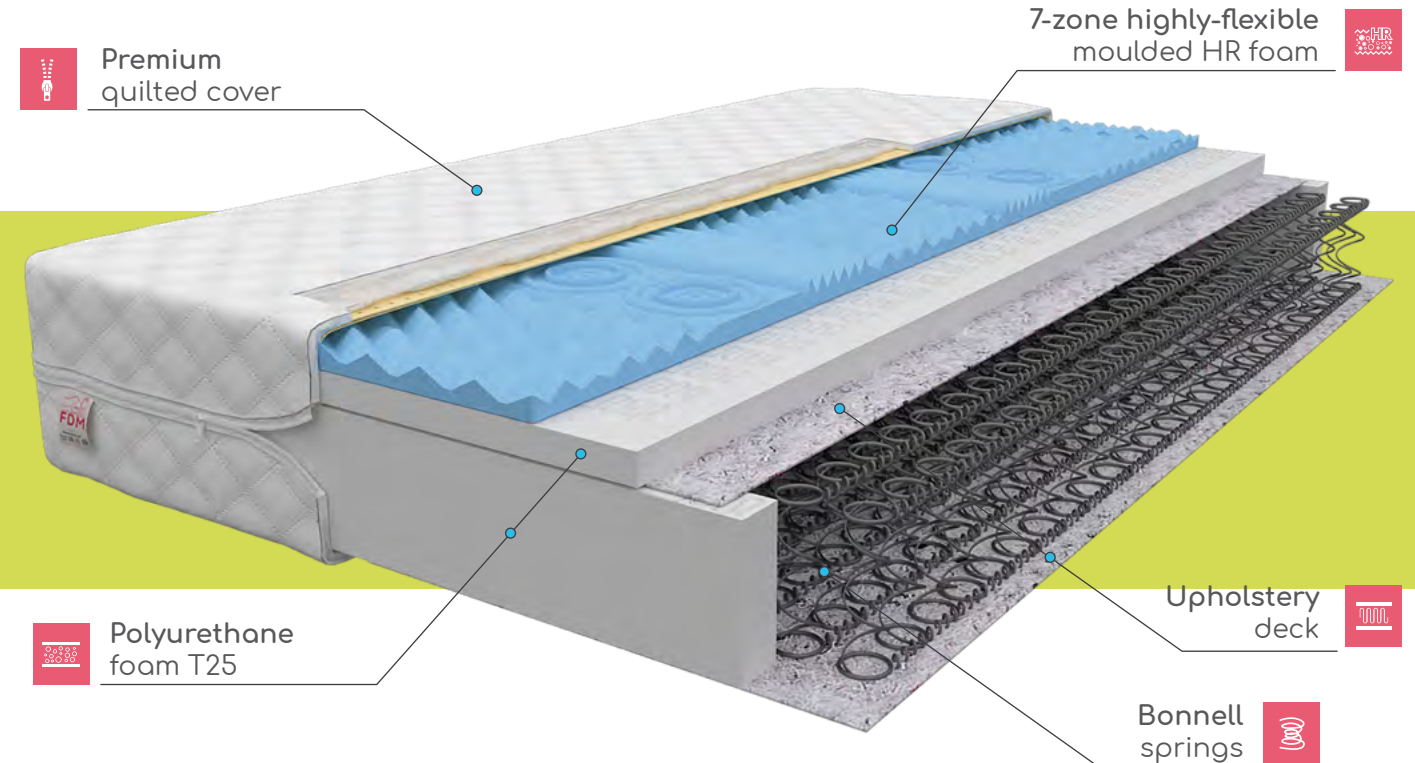

About the mattress

In **Baby Natural** mattress, in addition to springs made of hardened wire, a buckwheat deck has been used. Thus, this model is suitable for users suffering from different diseases. Buckwheat demonstrates orthopedic properties, prevents from spinal malformations and treats the already existing ones.

Mattress structure

	Natural Buckwheat	1 cm
	Polyurethane foam	2 cm
	Upholstery deck	
	Bonnell springs	10 cm
	Upholstery deck	

What distinguishes this mattress from the others?



About the mattress

Bambino is a mattress based on a deck with bonnell springs, combined on one side, made of high-quality moulded HR and polyurethane foam. These materials have been selected to provide high elasticity of the surface and proper support for the spine of your child. The use of two types of foams increases the feeling of lightness by adjusting to the body shape.

Mattress structure

	Moulded HR foam	2 cm
	Polyurethane foam	2 cm
	Upholstery deck	
	Bonnell springs	10 cm
	Upholstery deck	

What distinguishes this mattress from the others?

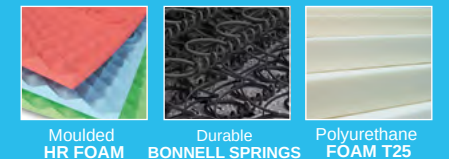

BITONTO

Foam Mattresses

↑ 15 cm

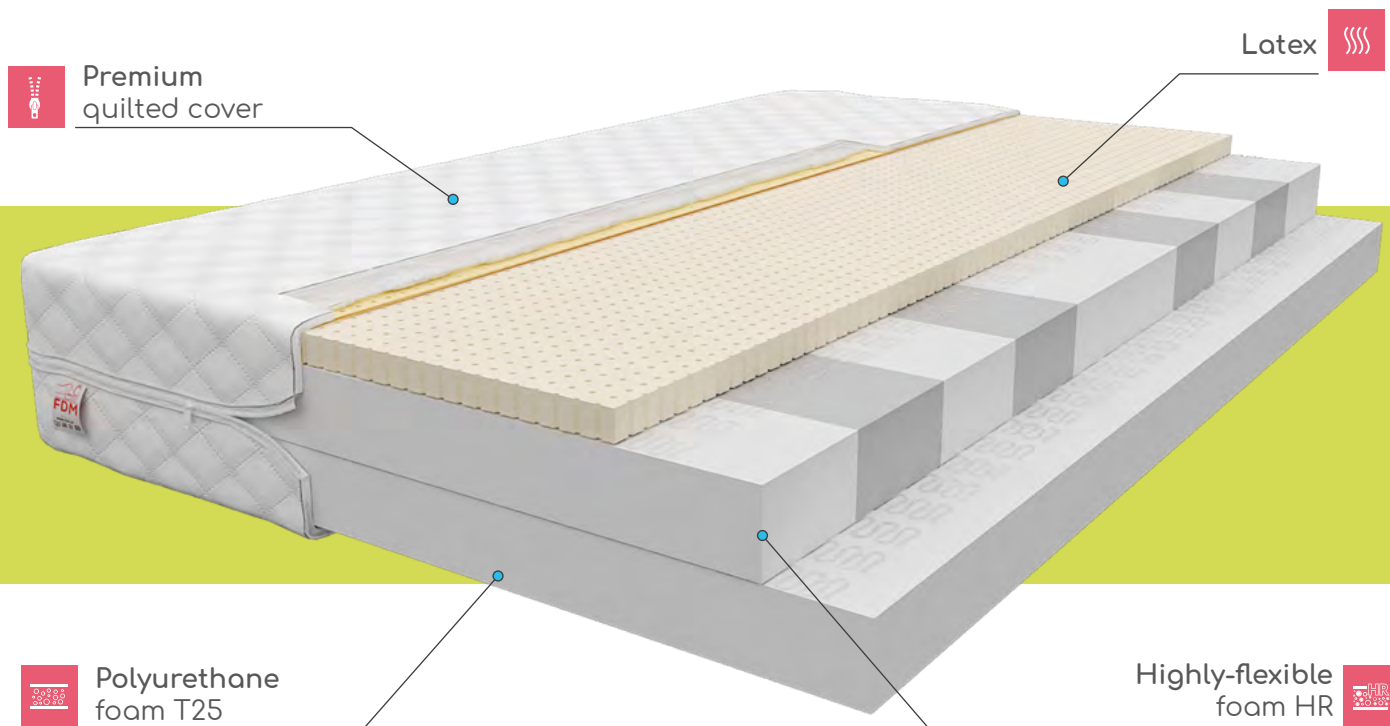

BRESSO

Foam Mattresses

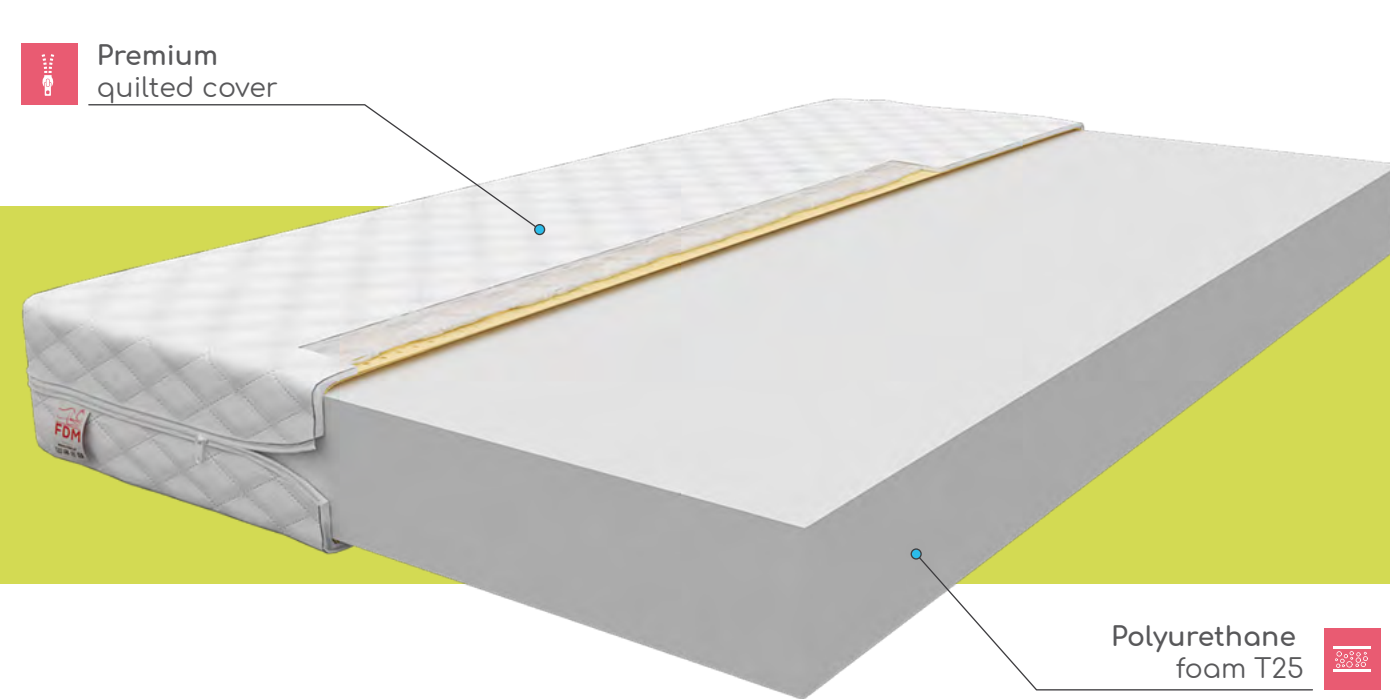

↑ 10 cm



About the mattress

If you look for a mattress with perfect ventilation, you should choose **Bitonto** model. It is based on the 7-zone highly-flexible HR foam which demonstrates resilience properties and supports the body perfectly. In addition, the mattress consists of latex which provides medicinal properties and perfect air circulation.

Mattress structure

	Latex	2 cm
	Highly-flexible foam HR	6 cm
	Polyurethane foam	6 cm

What distinguishes this mattress from the others?



About the mattress

Bresso is a classic model of mattress. It is made of 100% high-grade polyurethane foam T25. Thanks to the materials used in the production process, it does not deform so the mattress is very comfortable and provides good comfort of sleeping. It has a removable cover which provides high degree of hygiene of the user surface.

Mattress structure

	Polyurethane foam	9 cm
---	-------------------	------

Do you know that ...

Our covers have an inset zip fastener which allows to take them off easily and wash in 30°.



LATEX

Perfect ventilation and healthy sleep

Latex is a high-grade noble material. It adjusts precisely to the body shape. Each movement causes the layer of latex to compress and expand, allowing the internal canals to carry air. It demonstrates a wide range of anti-allergic properties, preventing from the formation of mould and acarus. Latex material features high-flexibility, it is durable and resistant to wear and tear, so it can be used for many years without visible changes in the structure or properties.

A material suitable for **ALLERGY SUFFERERS**

It has special **CANALS** CARRYING AIR



It prevents from **ACARUS FORMATION**



Excellent **AIR CIRCULATION**



This material is **100% ECOLOGICAL**



It is very **DURABLE**

CORATO

Foam Mattresses

↑ 11 cm

Premium quilted cover

Latex

Polyurethane foam T25

Highly-flexible foam HR

About the mattress

Corato model is based on highly-flexible HR foam which, compared to the traditional foam, provides better and more responsive adjustment to the body shape. In addition, this mattress consists of latex whose main benefits are flexibility and high degree of hygiene, so it is recommended for allergy sufferers.

Mattress structure

Latex	2 cm
Highly-flexible foam HR	6 cm
Polyurethane foam	2 cm

What distinguishes this mattress from the others?



7-zone HR FOAM



Polyurethane FOAM T25



Antiallergic LATEX

FAMILY kids

Pocket Mattresses

↑ 16 cm

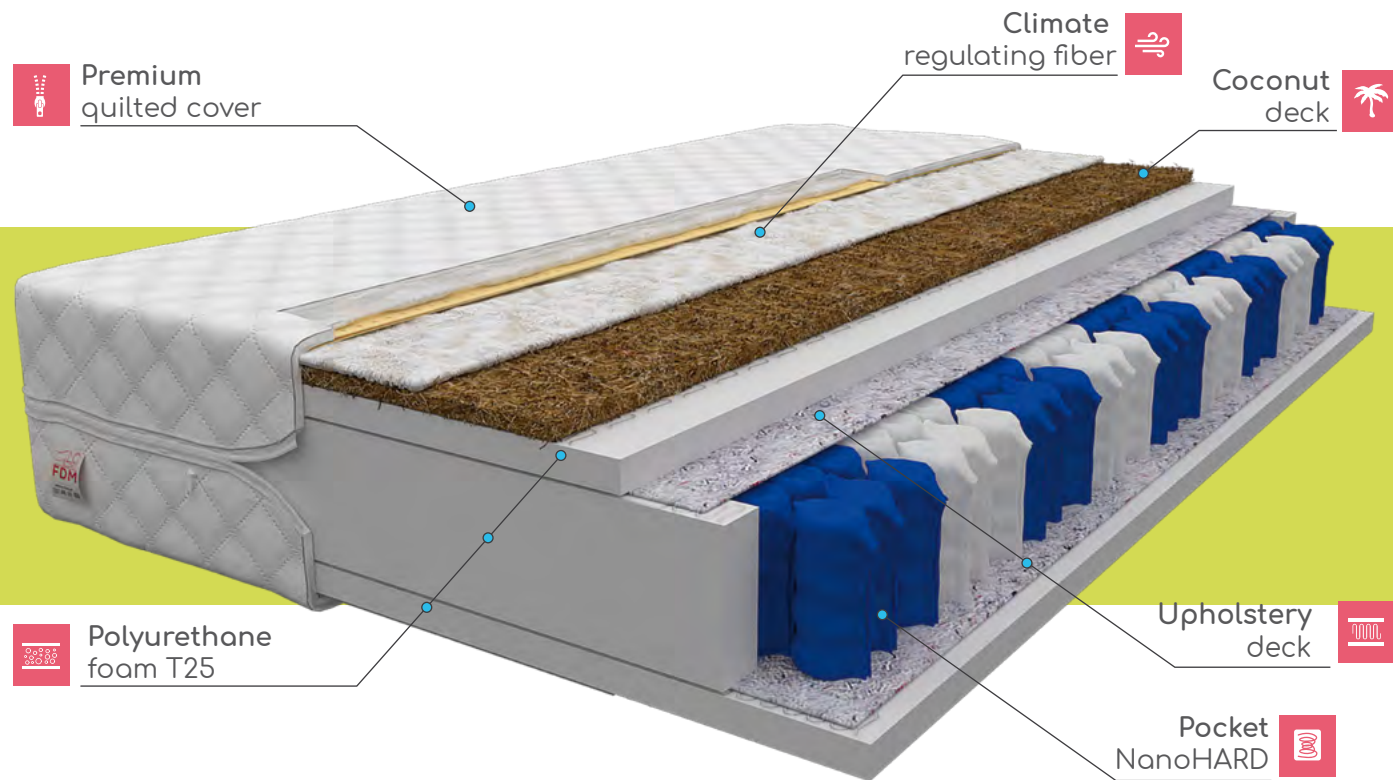

IRIS

Bonnell Mattresses

↑ 13 cm

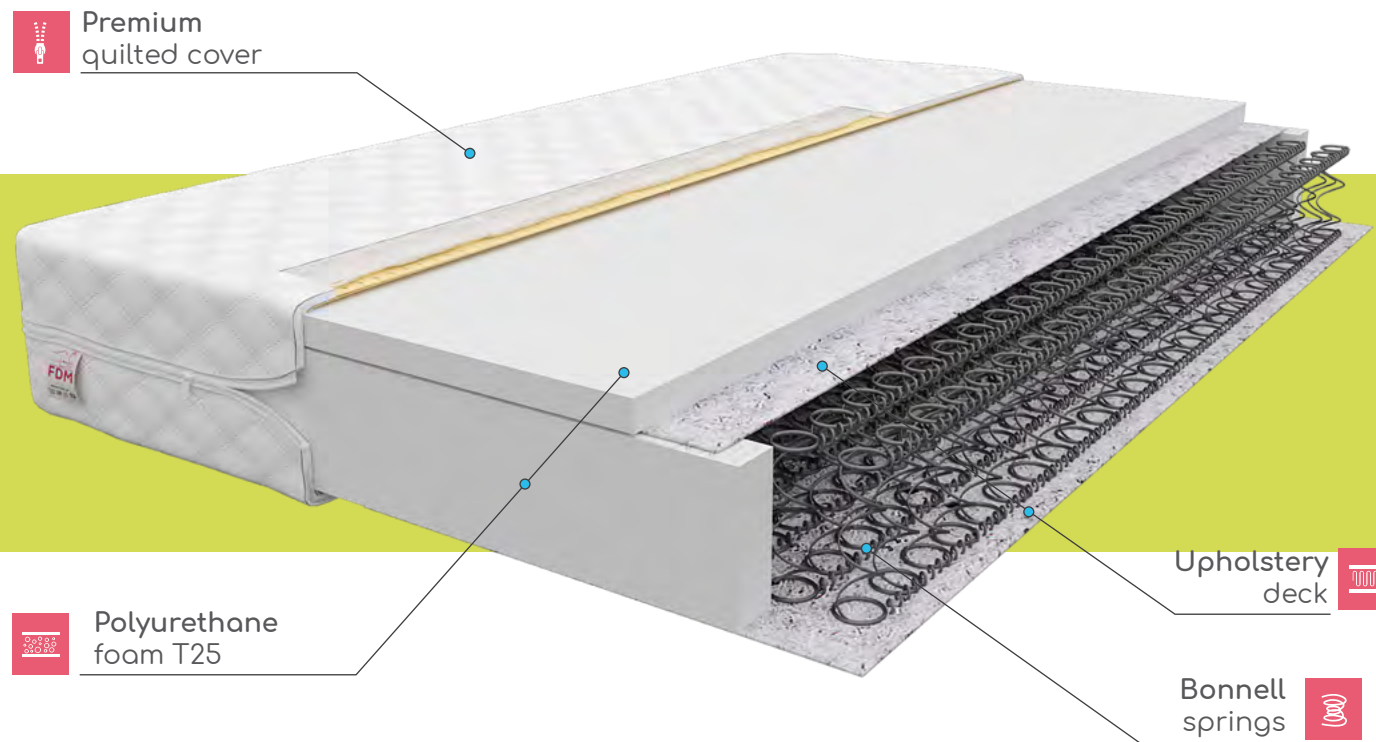

About the mattress

Family Kids is one of our top pocket mattresses models for children. It is based on the form of pocket springs made of double-hardened wire, covered with a 2 cm layer of polyurethane foam on both sides. In addition, this model has been enriched with a coconut layer which increases stiffness and improves air circulation inside.

Mattress structure

	Climate regulating fiber	1 cm
	Coconut deck	
	Polyurethane foam	2 cm
	Upholstery deck	
	Pocket NanoHARD	10 cm
	Upholstery deck	
	Polyurethane foam	2 cm

What distinguishes this mattress from the others?



About the mattress

Iris classic mattress is based on single aligned springs which are made of a very durable hardened wire. Durability and airiness are its main benefits. It is suitable for older children and teenagers.

Mattress structure

	Polyurethane foam	2 cm
	Upholstery deck	
	Bonnell springs	10 cm
	Upholstery deck	

The mattress consists of ca. 130 high-quality bonnell springs/m². They are highly-flexible, so they are suitable for different weight ranges.



LUGO

Foam Mattresses

↑ 10 cm

Premium quilted cover

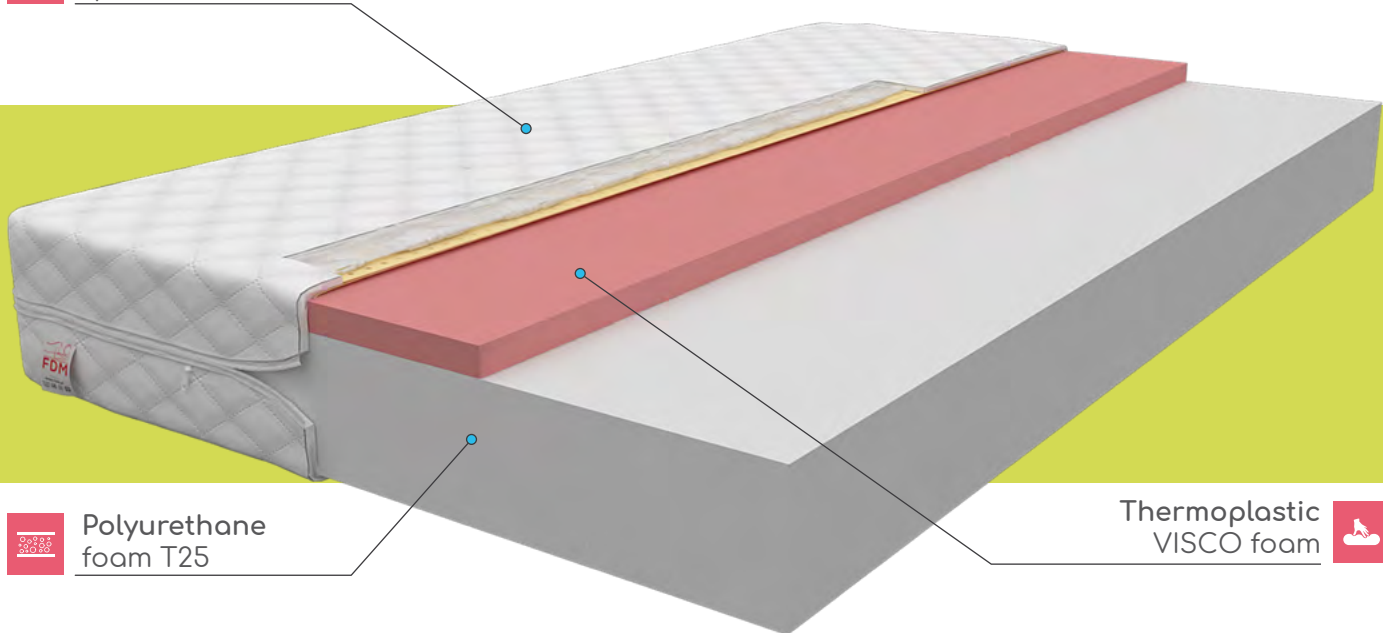

Polyurethane foam T25

Thermoplastic VISCO foam

LUIGI

Foam Mattresses

↑ 11 cm

Premium quilted cover

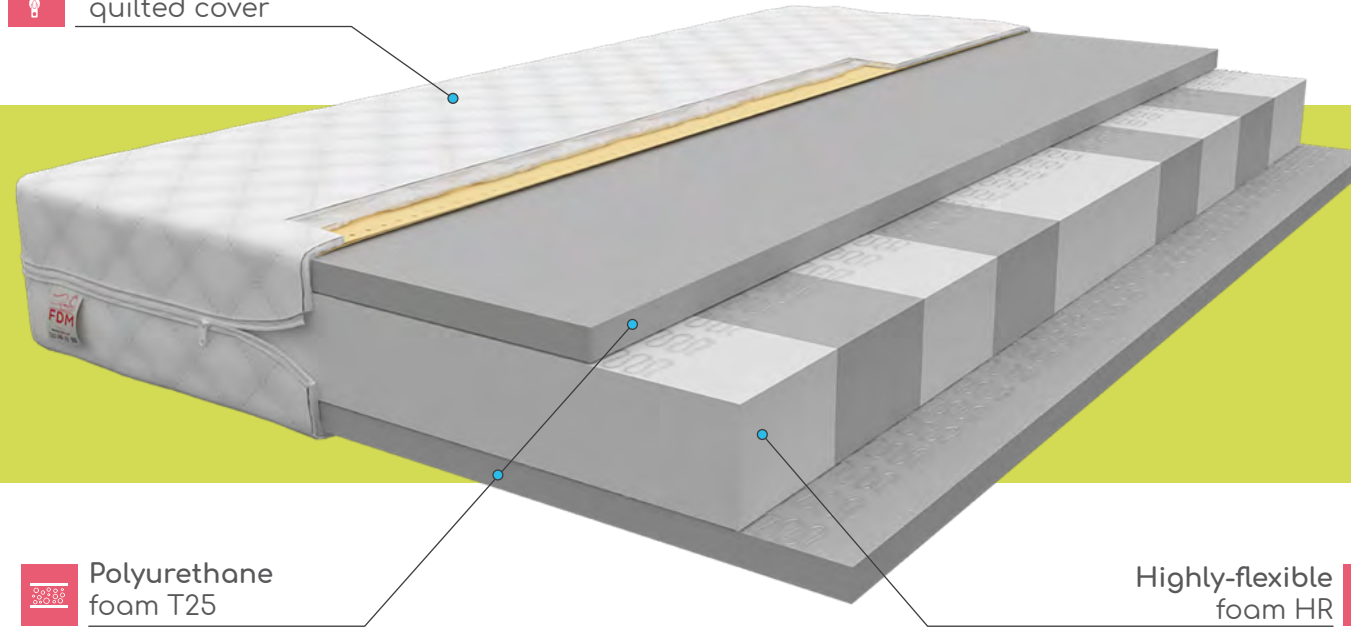

Polyurethane foam T25

Highly-flexible foam HR

About the mattress

LUGO is a combination of high-grade polyurethane foam T25 and thermoplastic foam VISCO. Thanks to this combination the mattress is safe, flexible and comfortable for the spine. It adjusts perfectly to the child's body shape, providing the feeling of comfort and safety.

Mattress structure

Thermoplastic VISCO foam	2 cm
Polyurethane foam	7 cm

T25 foams demonstrate high-density, proper hardness and elasticity featuring low susceptibility to deformation and high comfort of use.



About the mattress

LUIGI mattress is based on highly-flexible HR foam which demonstrates dynamic properties under load. Its additional benefit is perfect ventilation and resistance to stretching. It is covered with a T25 polyurethane foam which reinforces the mattress.

Mattress structure

Polyurethane foam	2 cm
Highly-flexible foam HR	6 cm
Polyurethane foam	2 cm

What distinguishes this mattress from the others?



7-zone HR FOAM

Polyurethane FOAM T25

MAYA

Pocket Mattresses

↑ 13 cm

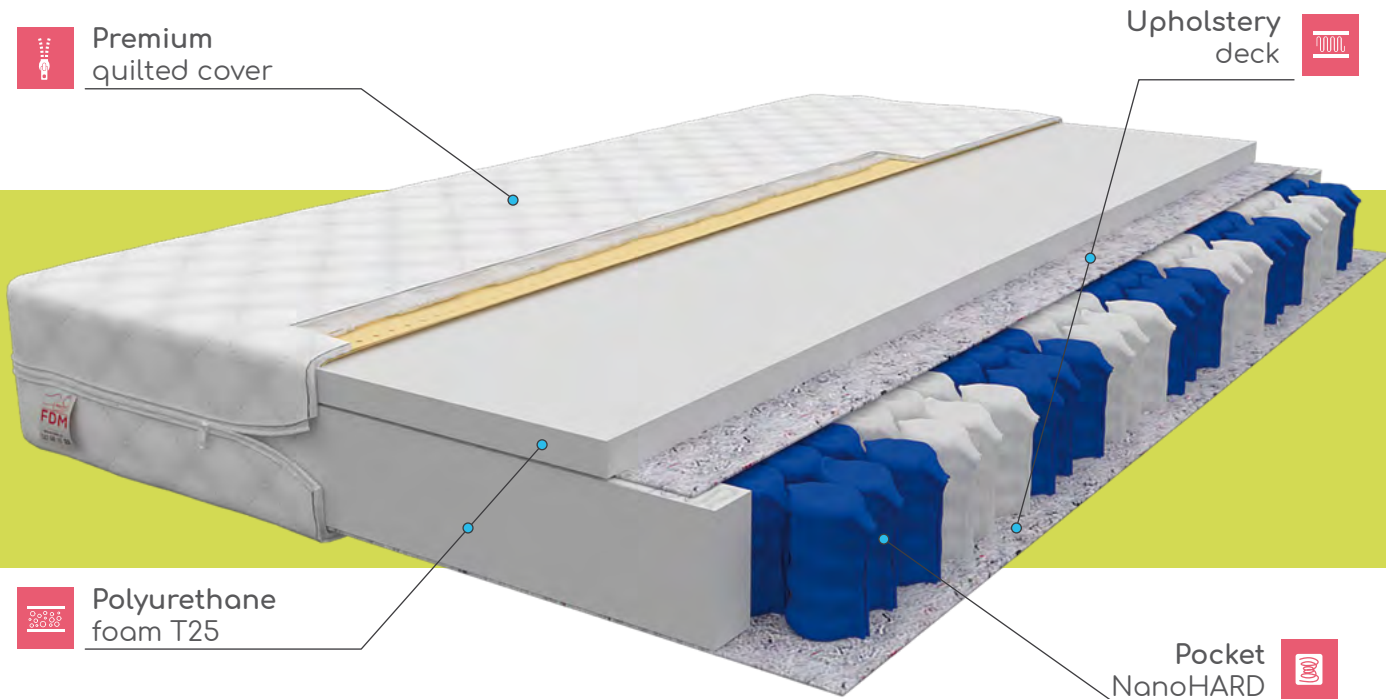

MILANO

Pocket Mattresses

↑ 14 cm

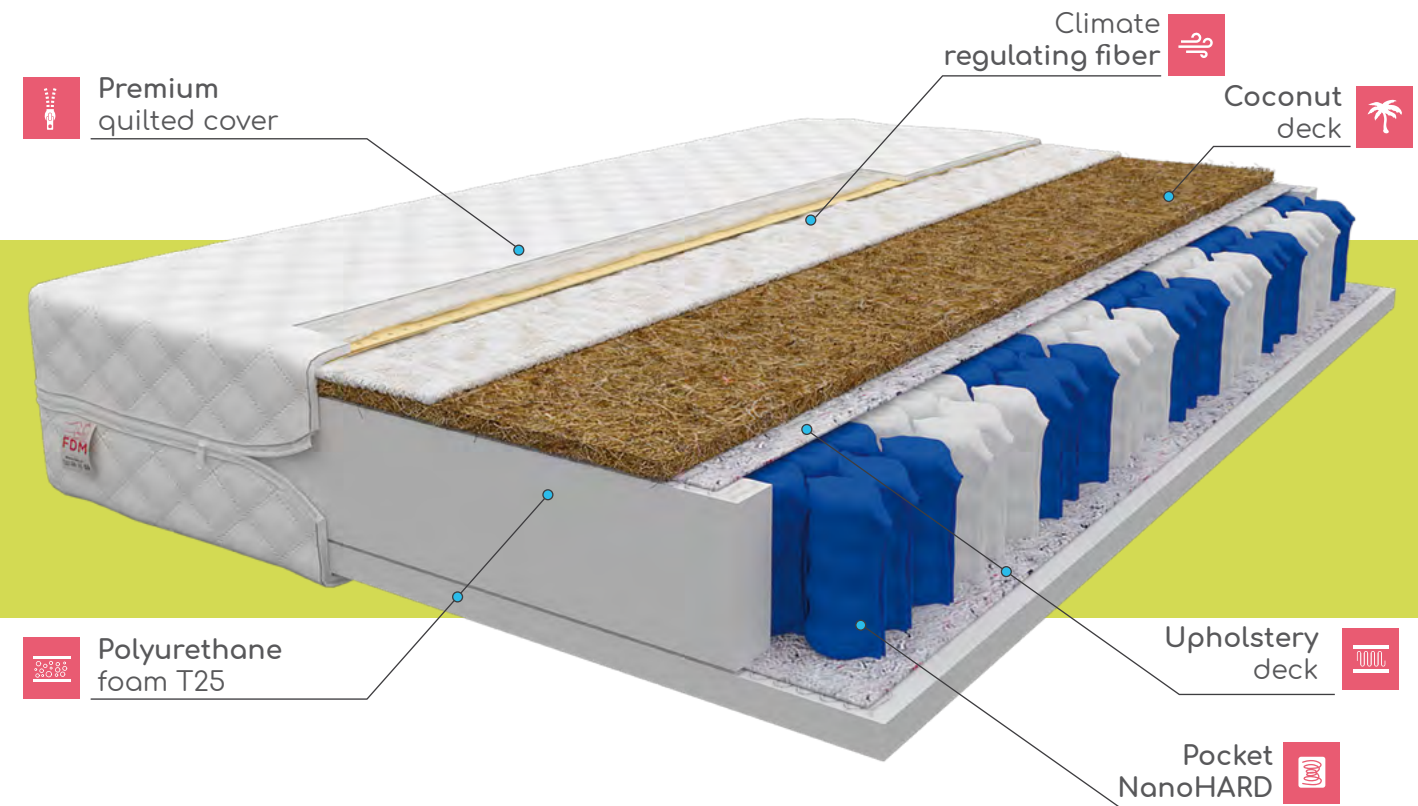

About the mattress

Mattress structure

What distinguishes this mattress from the others?

Maya model has been adjusted for users who prefer medium-hard surfaces. Thanks to its separation into 7 hardness zones, the form made of pocket springs provides a feeling of perfect adjustment to our body. Moreover, the polyurethane foam was used on one side, reinforcing the mattress structure.

	Polyurethane foam	2 cm
	Upholstery deck	
	Pocket NanoHARD	10 cm
	Upholstery deck	



7 HARDNESS ZONES POCKET SPRINGS Polyurethane FOAM T25

About the mattress

Mattress structure

What distinguishes this mattress from the others?

Milano is another offer among pocket mattresses. It is based on high-quality pocket springs which provide better adjustment to the child's body shape. In addition, this model has a layer of coconut, obtained from a natural coconut shell. Thus, this model features perfect ventilation inside the mattress, and stiffness.

	Climate regulating fiber	1 cm
	Coconut deck	
	Upholstery deck	
	Pocket NanoHARD	10 cm
	Upholstery deck	
	Polyurethane foam	2 cm



7 HARDNESS ZONES POCKET SPRINGS Ecological COCO Polyurethane FOAM T25

MILETO

Foam Mattresses

↑ 11 cm

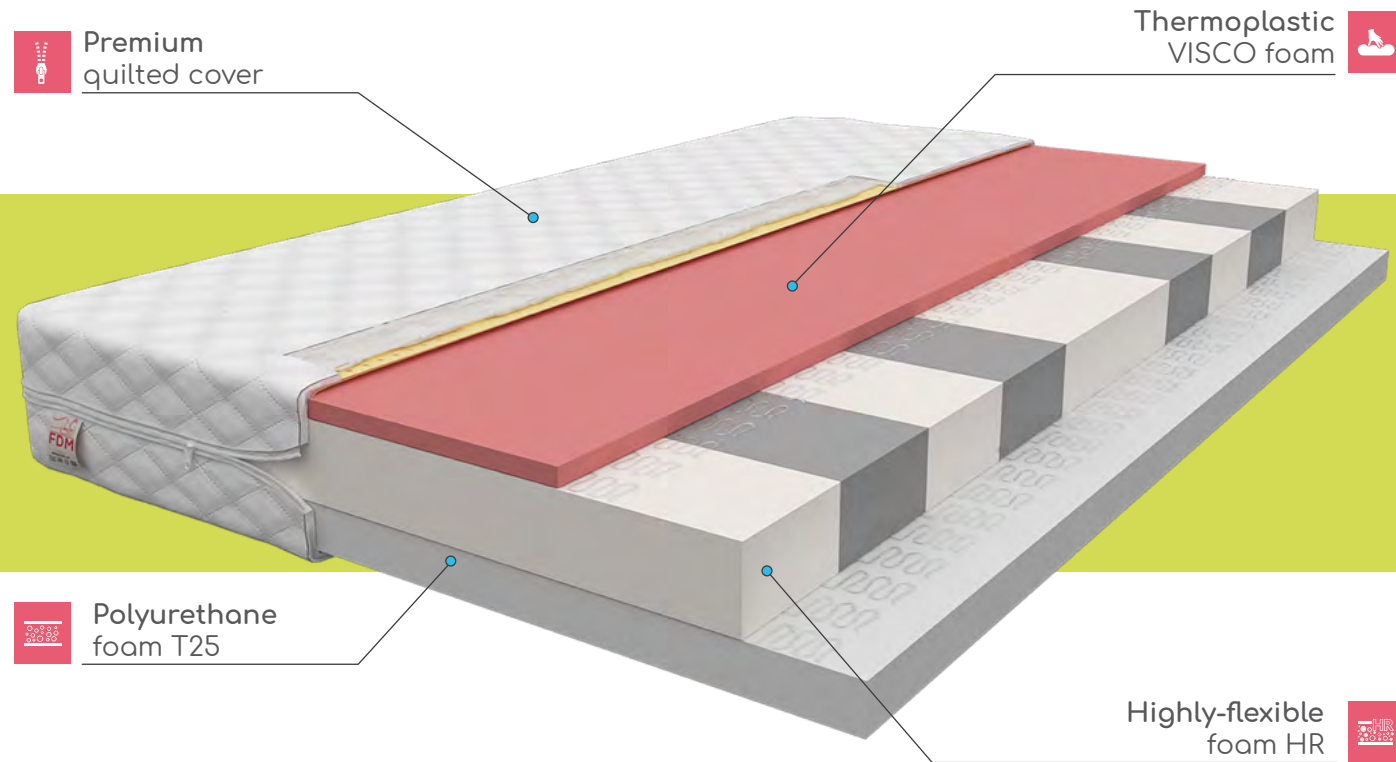

MONZA

Foam Mattresses

↑ 15 cm

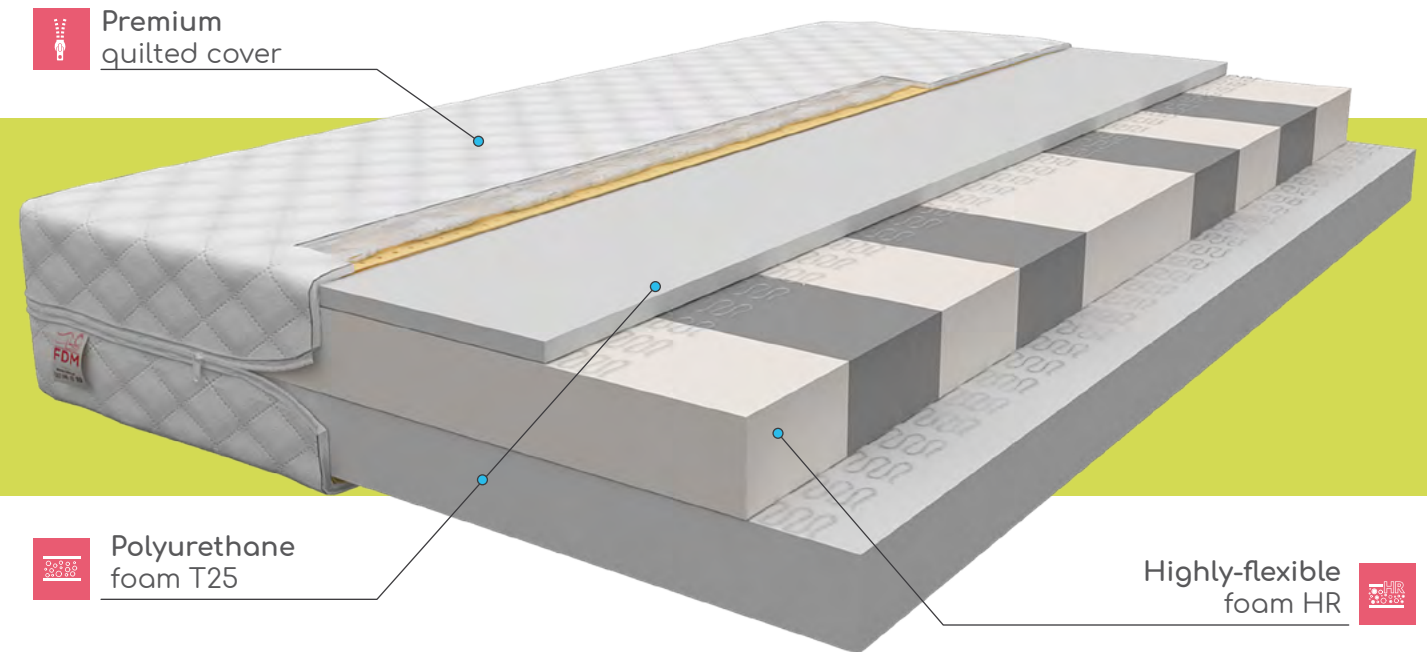

About the mattress

MILETO has been developed for parents who value most the comfort of relaxation of their children. Thanks to the combination of three high-quality foams (Hr, Visco and T25), the pressure points are reduced, providing even support for the whole body during the entire night.

Mattress structure

Thermoplastic VISCO foam	2 cm
Highly-flexible foam HR	6 cm
Polyurethane foam	2 cm

Thermoplastic VISCO foam was made in the technology developed by NASA in order to reduce the number of spine diseases.



About the mattress

Monza mattress has been made of superior highly-flexible HR foam. Its most significant features are long lifetime, very good air circulation and good adjustment to the body shape. An additional benefit of our mattresses is a quilted cover included, which can be taken off easily and washed in 30°.

Mattress structure

Polyurethane foam	2 cm
Highly-flexible foam HR	6 cm
Polyurethane foam	6 cm

What distinguishes this mattress from the others?



7-zone HR FOAM

Polyurethane FOAM T25

The latest technology Thermoplastic

VISCO



Foam

The thermoplastic VISCO foam with body memory function is sensitive to pressure and temperature. It is a technology developed by NASA in order to reduce the number of spine diseases. It is now available in mattresses for children.

- Adjusts to the body shape
- Sensitive to temperature and pressure
- Reduces pressure on the whole body surface area
- Improves the quality of relaxation and comfort of sleeping
- Reduces muscle tension



PADWA

Foam Mattresses

↑ 16 cm

Premium quilted cover

Natural Buckwheat

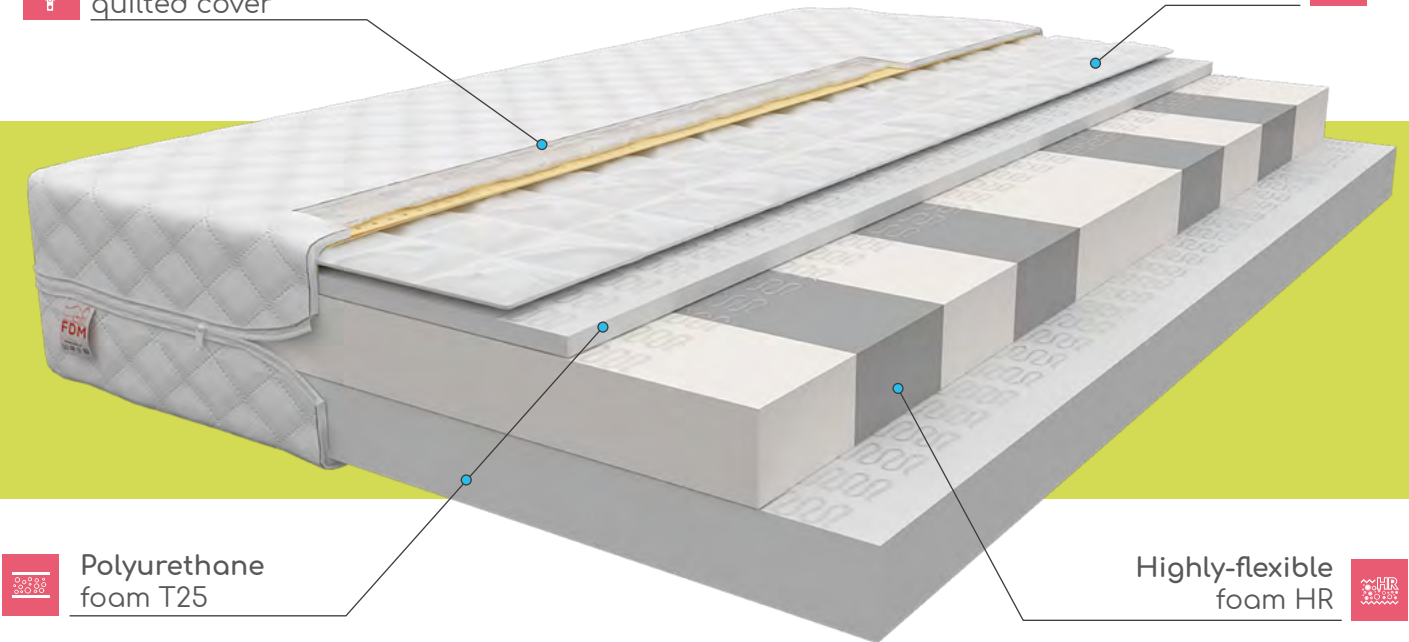

Polyurethane foam T25

Highly-flexible foam HR

About the mattress

PADWA model is particularly recommended for children and teenagers who, besides relaxation, want to take care of their spines and proper position of the body while sleeping. In addition to the 7-zone highly-flexible HR foam, the mattress consists of a layer of natural buckwheat with medicinal properties, providing hygiene and proper ventilation of the space we sleep on.

Mattress structure

	Natural Buckwheat	1 cm
	Polyurethane foam	2 cm
	Highly-flexible foam HR	6 cm
	Polyurethane foam	6 cm

What distinguishes this mattress from the others?



PARMA

Foam Mattresses

↑ 15 cm

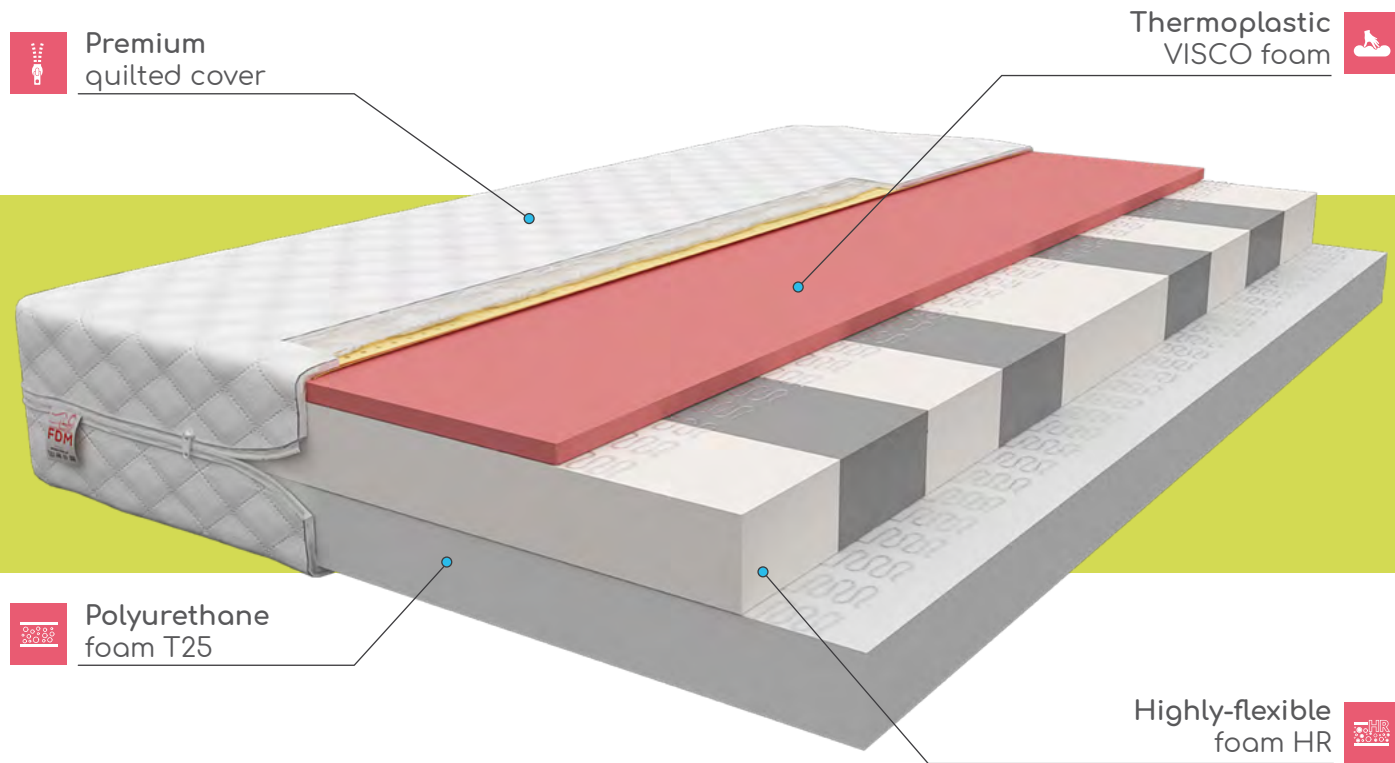

PIKOLO

Foam Mattresses

↑ 11 cm

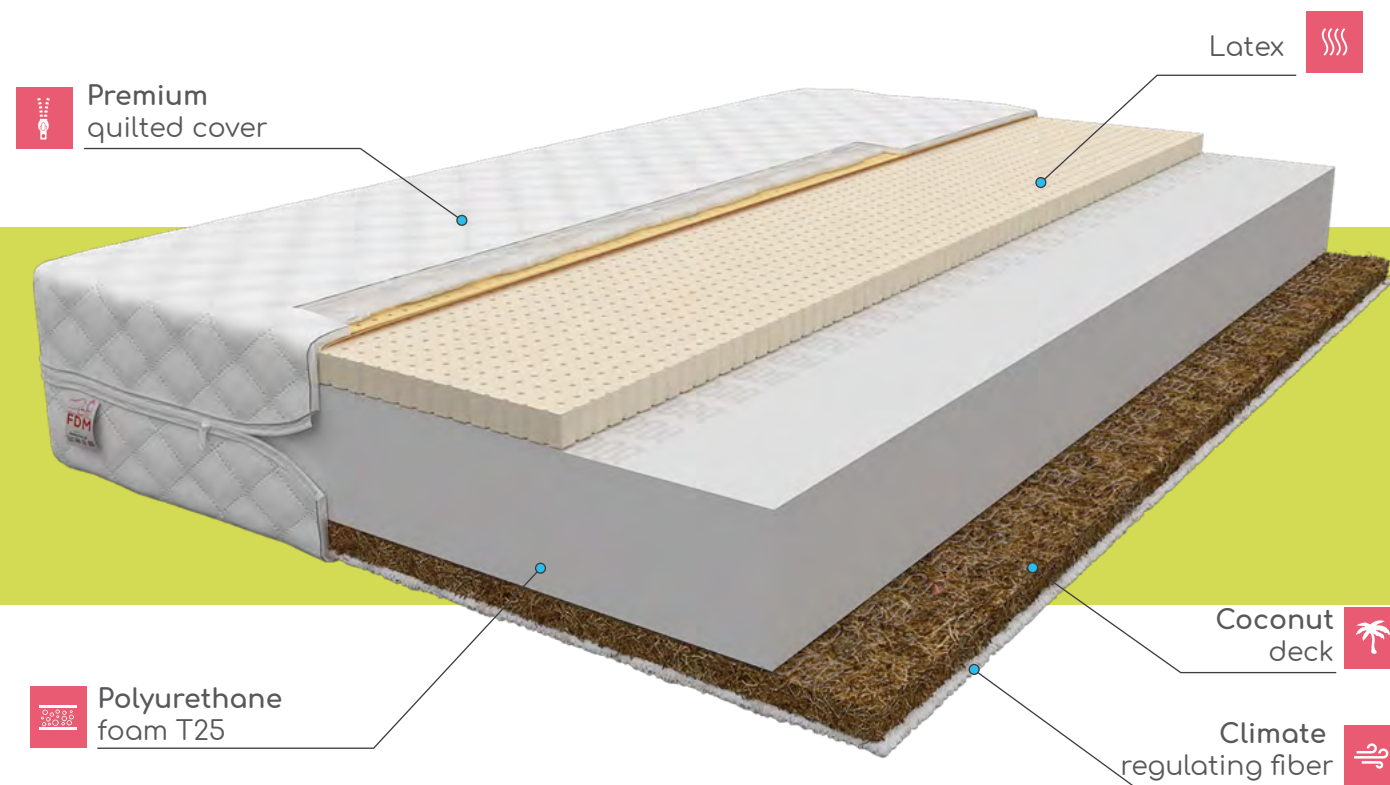

About the mattress

Parma mattress is distinguished by the highly-flexible HR foam. It features high flexibility and excellent air permeability. Upon removal of load, it regains its original shape. The mattress also consists of thermoplastic VISCO and polyurethane foam both of which improve the comfort of use of this model even more.

Mattress structure

Thermoplastic VISCO foam	2 cm
Highly-flexible foam HR	6 cm
Polyurethane foam	6 cm

What distinguishes this mattress from the others?



About the mattress

Pikolo is a model which combines three high-quality materials: polyurethane foam, coconut and latex. They provide proper position of the body of a child while sleeping or relaxing. This is a two-sided mattress, so its hardness grade can be adjusted individually. It is recommended for allergy sufferers due to their proper degree of hygiene.

Mattress structure

Latex	2 cm
Polyurethane foam	7 cm
Coconut deck	1 cm
Climate regulating fiber	

What distinguishes this mattress from the others?



ROVIGO

Foam Mattresses

↑ 17 cm

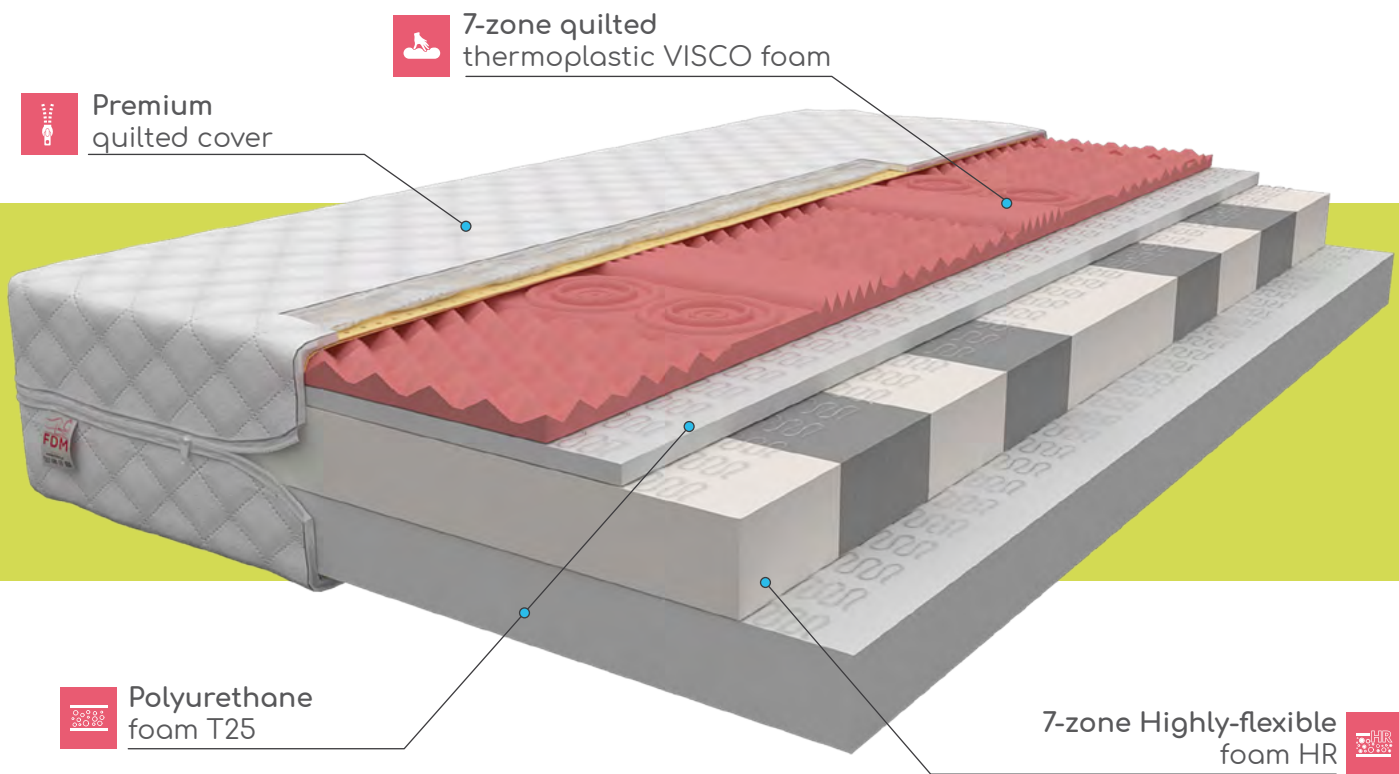

SIENA

Bonnell Mattresses

↑ 16 cm

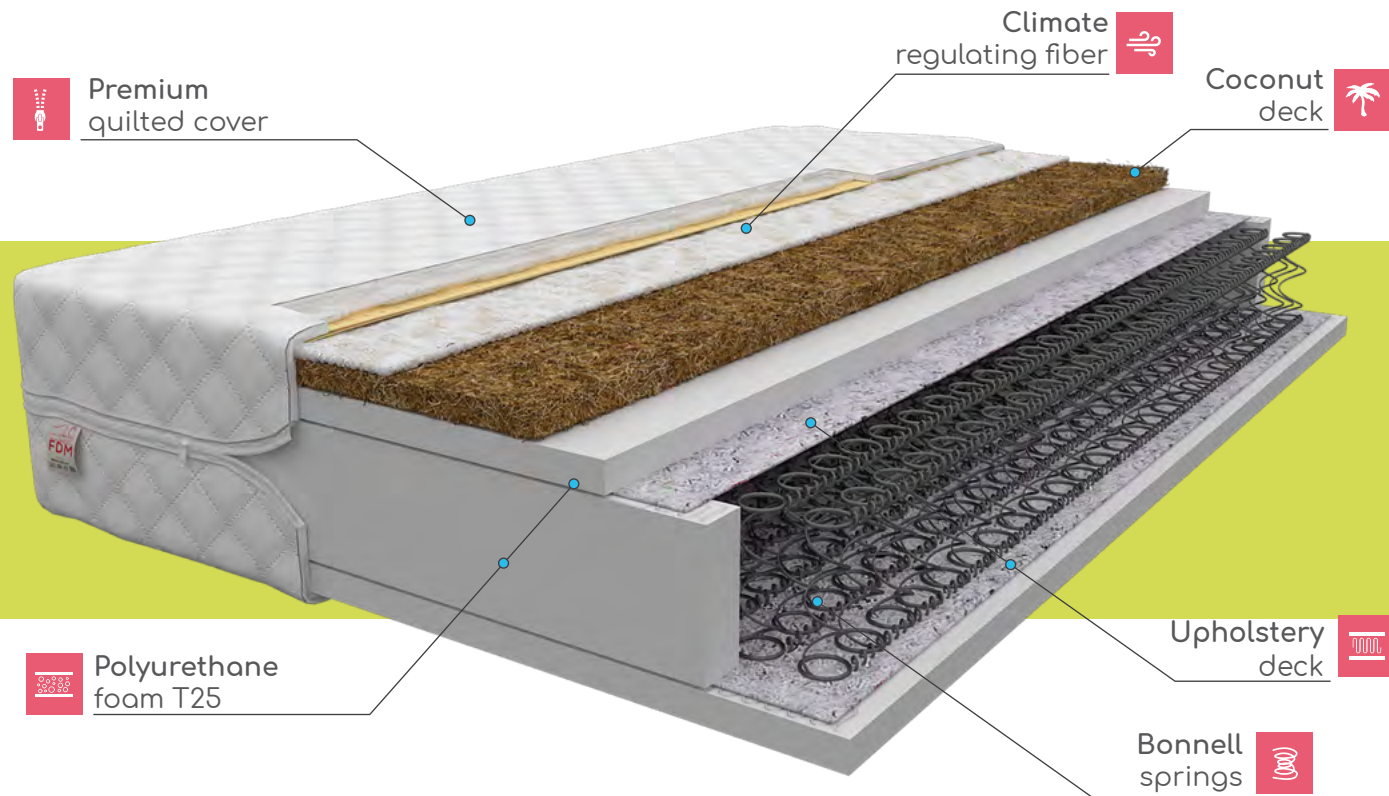

About the mattress

Rovigo mattress is made of the combination of thermoplastic foam with elastic memory, highly-flexible resilient HR foam and reinforced polyurethane foam. Thanks to this combination, the mattress features unique resistance to deformation and perfect adjustment to the body shape.

Mattress structure

Quilted thermoplastic VISCO foam	2 cm
Polyurethane foam	2 cm
Highly-flexible foam HR	6 cm
Polyurethane foam	6 cm

What distinguishes this mattress from the others?



About the mattress

The structure of **Sienna** mattress is based on the deck made of highly-resistant bonnell springs. In addition, it has been equipped with a coconut deck on one side which prevents from the development of acarus and microorganisms, and prevents from deformation.

Mattress structure

Climate regulating fiber	1 cm
Coconut deck	2 cm
Polyurethane foam	2 cm
Upholstery deck	10 cm
Bonnell springs	10 cm
Upholstery deck	2 cm
Polyurethane foam	2 cm

What distinguishes this mattress from the others?

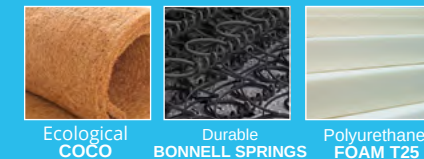

SORRENTO

Foam Mattresses

↑ 11 cm

Premium quilted cover

7-zone highly-flexible moulded HR foam

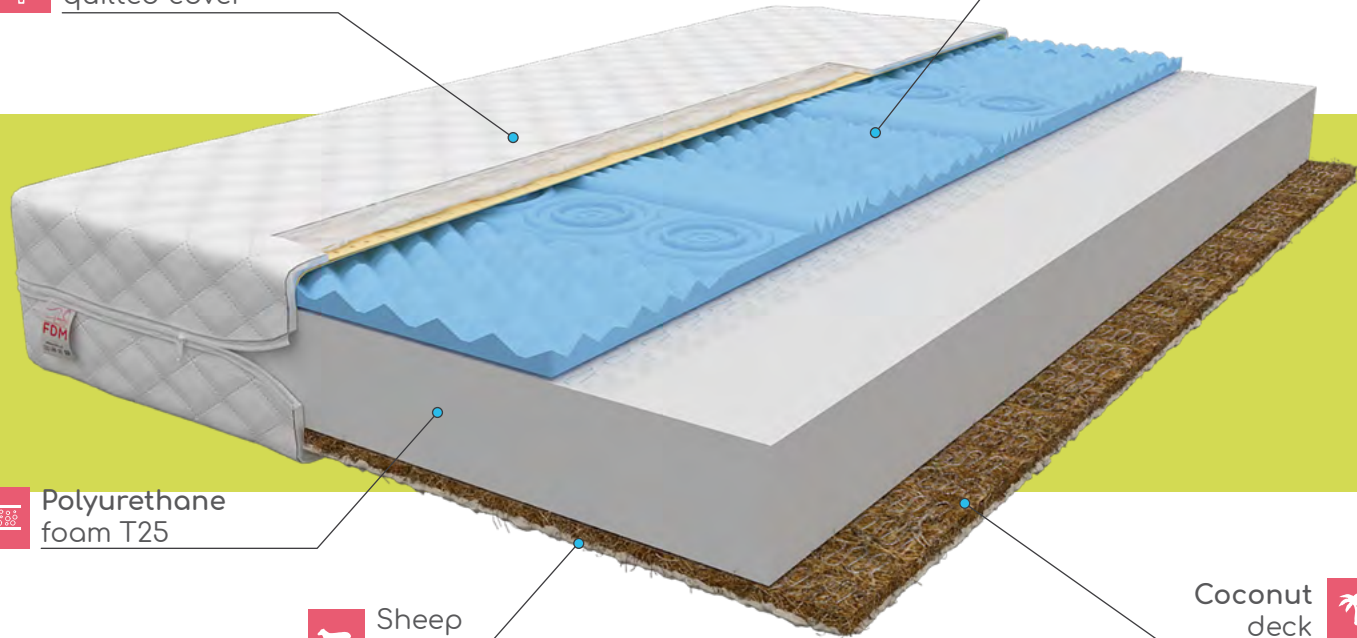

Polyurethane foam T25





Sheep wool

Coconut deck

About the mattress

Sorrento model is based on the high-grade foam T25. A coconut layer, which stiffens the mattress and protects it from microorganisms and acarus penetration, was added to one side. The other side has been enriched with moulded HR foam which adjusts perfectly to the body, providing the feeling of extra lightness.

Mattress structure

	Moulded HR foam	2 cm
	Polyurethane foam	7 cm
	Coconut deck	1 cm
	Sheep wool	

What distinguishes this mattress from the others?



Moulded HR FOAM



Ecological COCO



Polyurethane FOAM T25

The highest sleeping comfort

HR FOAM

Highly-flexible polyurethane foam

Highly-flexible HR foam has an uneven and porous structure which provides excellent air circulation, preventing from the formation of mould. Moreover, it demonstrates better parameters of supporting the body, comfort and elasticity than the traditional foams. It is suitable for mattresses for children and teenagers.

- Higher flexibility, better adjustment to the body shape
- More durable by 40% than traditional foams
- Perfect support for the spine



TERAMO

Foam Mattresses

↑ 14 cm

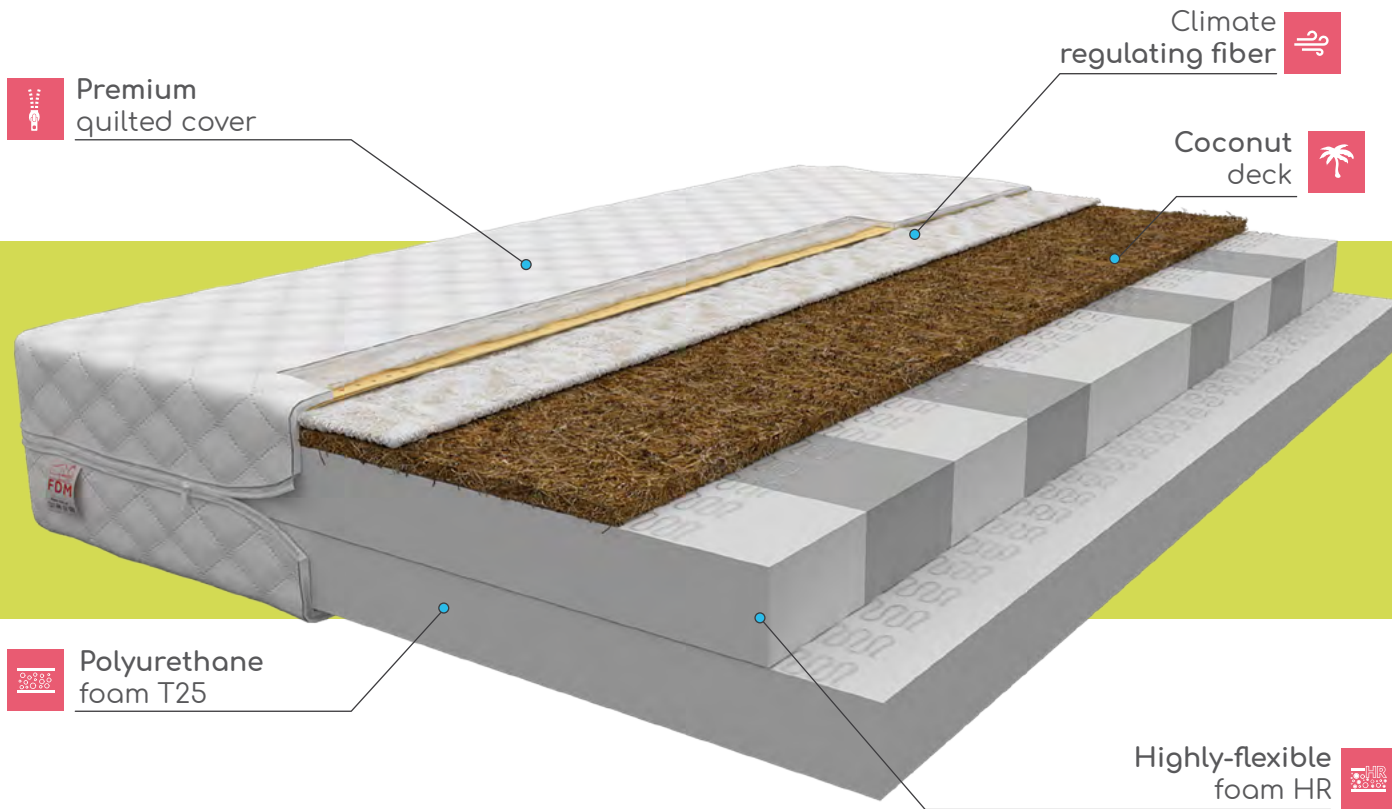

TORINO

Pocket Mattresses

↑ 16 cm

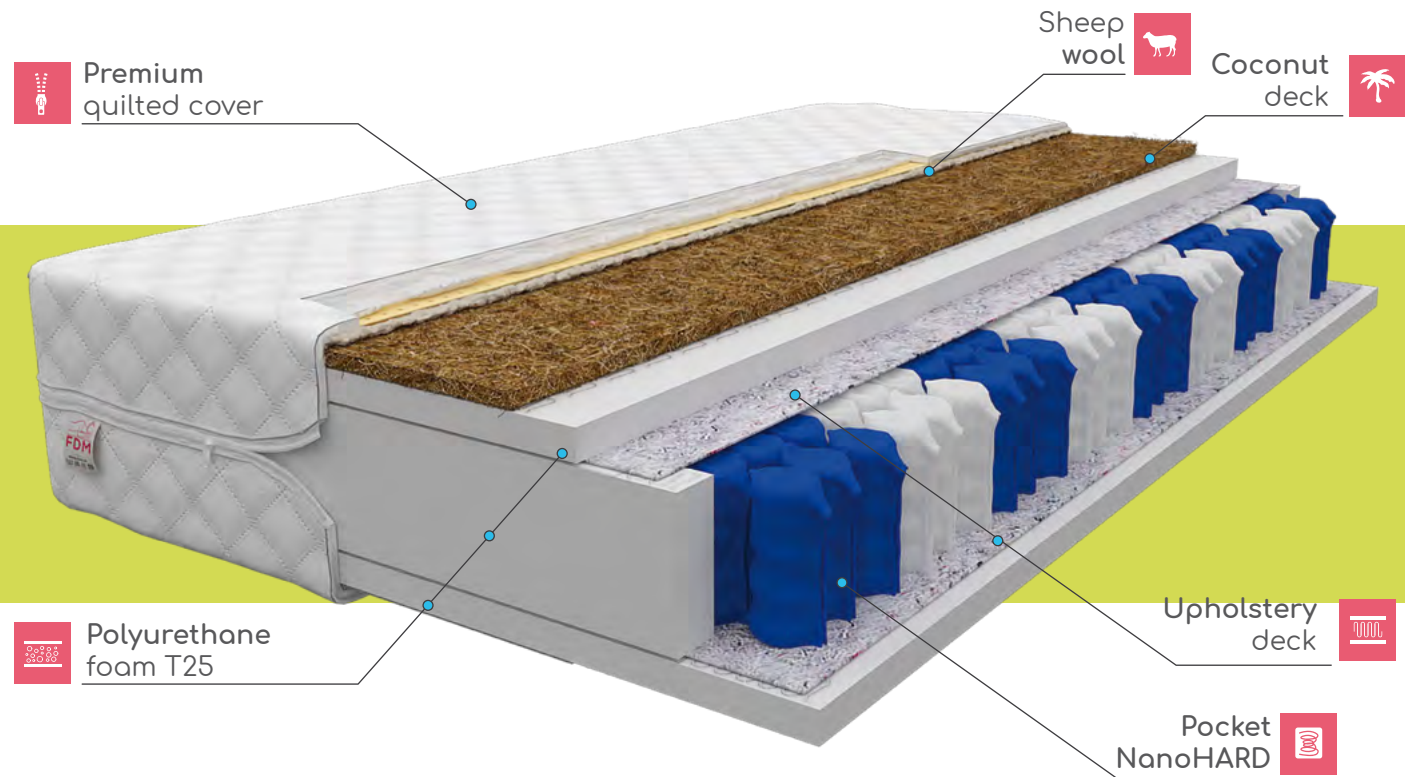

About the mattress

Teramo is a superior mattress. The 7-zone HR foam is more durable even by 40% than the traditional polyurethane foam with the same density, and regains its original shape two times faster. The coconut deck prevents from the development of acarus and microorganisms, it is resilient and flexible. Moreover, the antiallergic cover prevents from bacteria, mould and acarus formation.

Mattress structure

Climate regulating fiber	1 cm
Coconut deck	
Highly-flexible foam HR	6 cm
Polyurethane foam	6 cm

What distinguishes this mattress from the others?



7 HARDNESS ZONES HR FOAM Polyurethane FOAM T25 Ecological COCO

About the mattress

Thanks to the combination of pocket springs, two layers of polyurethane foam and a coconut layer, **Torino** mattress features durability and resistance for many years. Coconut provides stiffness and improves air circulation. It also forms a natural barrier, preventing the mattress from microorganisms and mould. Pocket used as the base for a mattress has 7 hardness zones, providing perfect adjustment to the body shape.

Mattress structure

Sheep wool	1 cm
Coconut deck	
Polyurethane foam	2 cm
Upholstery deck	
Pocket NanoHARD	10 cm
Upholstery deck	
Polyurethane foam	2 cm

What distinguishes this mattress from the others?



7 HARDNESS ZONES POCKET SPRINGS Ecological COCO Polyurethane FOAM T25

TREVISO

Pocket Mattresses

↑ 15 cm

Premium quilted cover

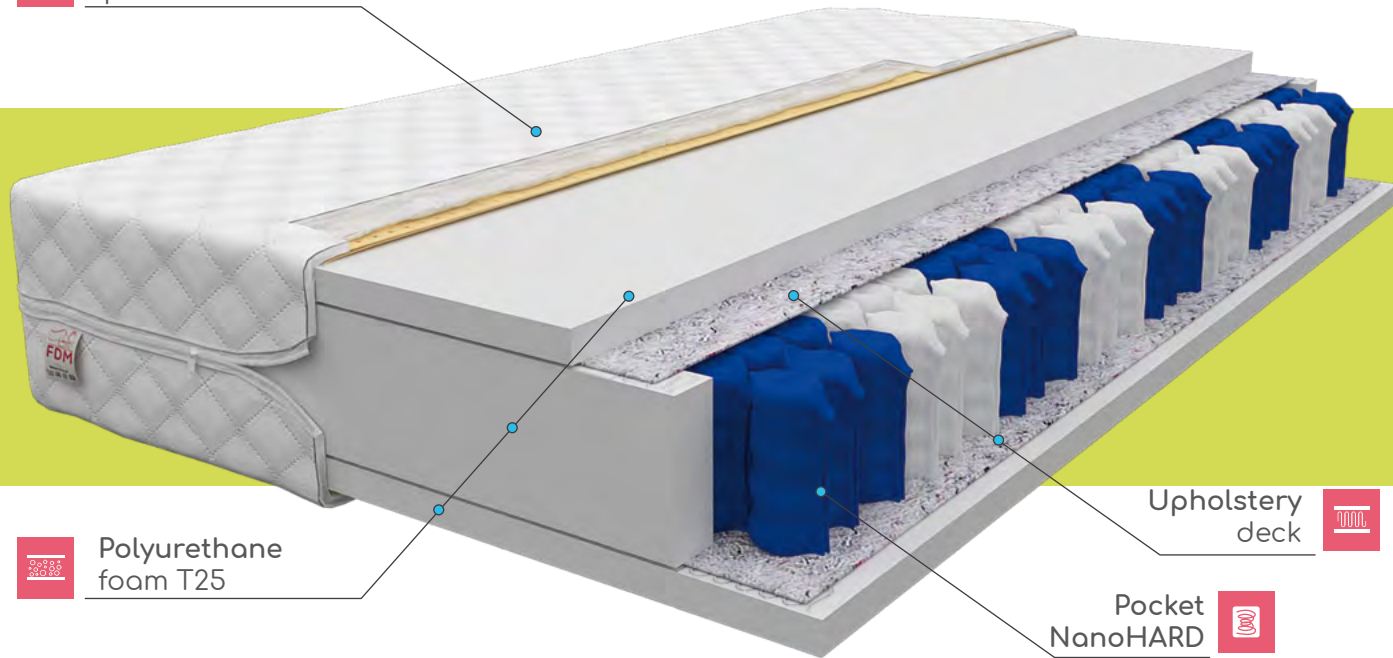

Polyurethane foam T25

Upholstery deck

Pocket NanoHARD

TORO kids

Latex Mattresses

↑ 10 cm

Premium quilted cover

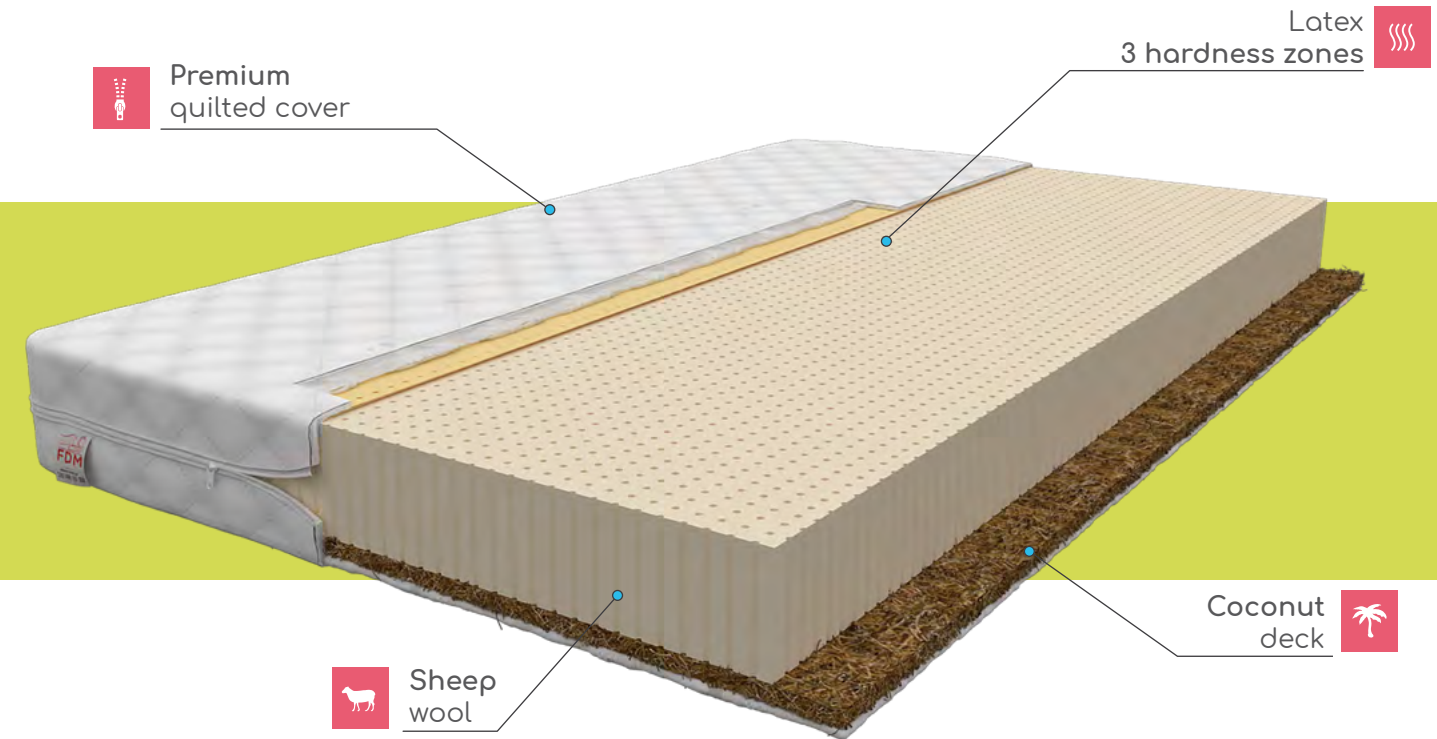

Lotex 3 hardness zones

Sheep wool

Coconut deck

About the mattress

Treviso is a classic pocket mattress model. Thanks to the used form made of double hardened pocket springs, you can be sure that you buy a high-quality mattress which will be usable for many years. The separation of user surface into 7 hardness zones provides good support for each body part during relaxation.

Mattress structure

	Polyurethane foam	2 cm
	Upholstery deck	
	Pocket NanoHARD	10 cm
	Upholstery deck	
	Polyurethane foam	2 cm

What distinguishes this mattress from the others?



7 HARDNESS ZONES
POCKET SPRINGS

Polyurethane
FOAM T25

About the mattress

Toro Kids mattress is based on the highest-grade latex foam. This material is extremely durable, gentle and ecological. It has a porous structure which provides perfect air circulation inside the mattress. In addition, it has been stiffened with a coconut mat on one side for children who prefer harder surfaces.

Mattress structure

	Latex	8 cm
	Coconut deck	1 cm
	Sheep wool	

What distinguishes this mattress from the others?



Antiallergic
LATEX

UDINE kids

Latex Mattresses

↑ 9 cm

Premium quilted cover

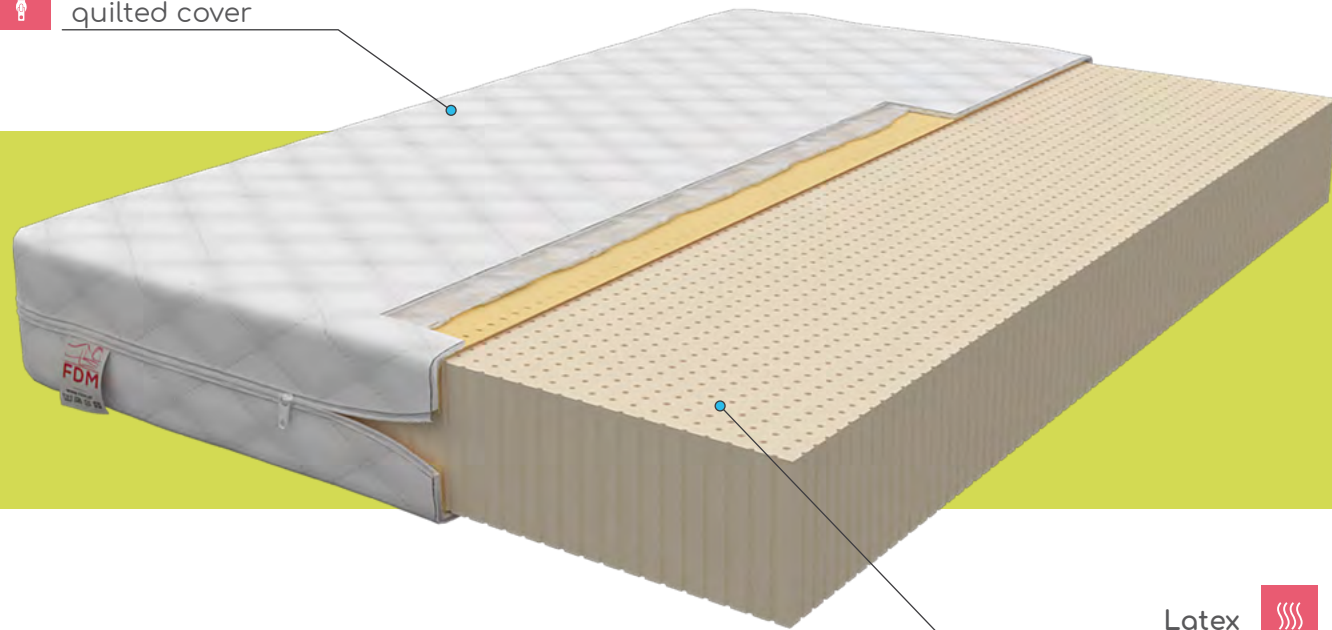

Latex



VASTO

Pocket Mattresses

↑ 20 cm

Premium quilted cover

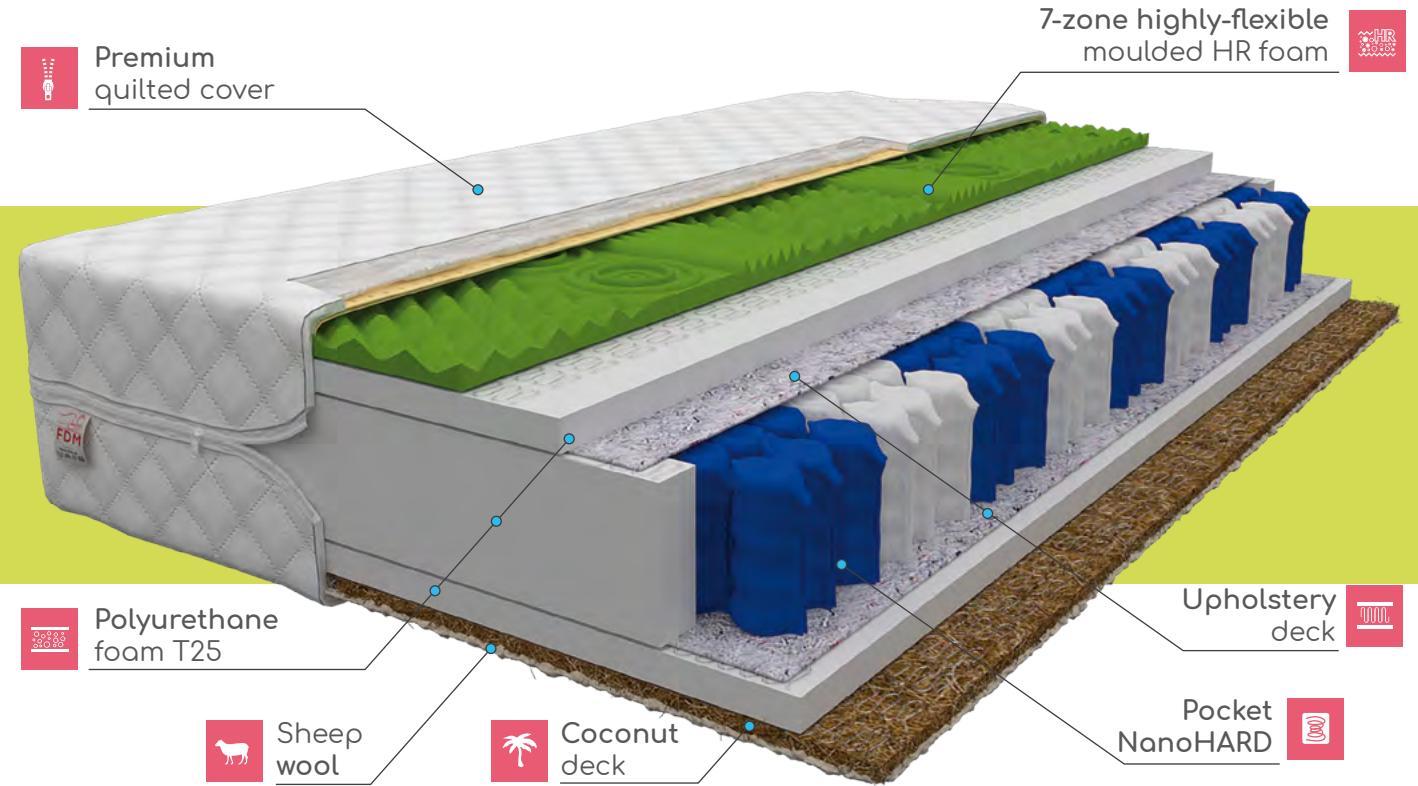

7-zone highly-flexible moulded HR foam

Polyurethane foam T25

Sheep wool

Coconut deck

Upholstery deck

Pocket NanoHARD

About the mattress

Udine mattress has been made of 100% latex with three hardness zones. Latex material has special canals carrying air from the mattress inside, providing constant breathing and ventilation which reduced the risk of formation of mould inside the mattress.

Mattress structure

Latex 8 cm

Why latex IS A GOOD CHOICE ?

Thanks to special canals carrying air, Latex material creates a feeling of coolness.



About the mattress

If you look for a long-lasting mattress, **Vasto** model will be the most reasonable choice. It is two-sided and has two hardness grades. If your child prefers harder surfaces, the most suitable would be the coconut layer side. The deck made of moulded polyurethane HR foam adjusts perfectly to the body, providing a feeling of pleasant lightness.

Mattress structure

Moulded HR foam	2 cm
Polyurethane foam	2 cm
Upholstery deck	
Pocket NanoHARD	12 cm
Upholstery deck	
Polyurethane foam	2 cm
Coconut deck	1 cm
Sheep wool	

What distinguishes this mattress from the others?



7 HARDNESS ZONES POCKET SPRINGS Ecological COCO Moulded HR FOAM

WATERPROOF PROTECTOR

for even better protection

Maintaining hygiene is very important when it comes to mattresses. The hygiene of sleeping environment highly affects our health, particularly if we suffer from different types of allergies. So, it must be taken care of properly. The mattress protector performs its function. It has durable rubbers at the corners. Thus, the protector will not move on the surface of the mattress. The protector is very simple to put on and easy to use.

ROYAL

FABRIC WEIGHT:
170 gr/cm² (±10)

CLASSIC

FABRIC WEIGHT:
105 gr/cm² (±5)

COVERS

Each mattress has a quilted Premium Jersey 3D cover included. It has been made from the highest-quality first-grade hypoallergenic materials, which guarantees a prolonged lifetime of your mattress, providing unique softness, freshness and exceptional comfort and satisfaction from its use.

Properties:

100% polyester, antiallergic, airy, sensuous, dirt resistant, stretch resistant, provides good ventilation, to be washed in 30°C.

Other covers with additional properties have been presented below.



ALOEVERA BONES 3D



Aloe Vera Bones 3D is made of 100% polyester and moistened with aloe extract. Thus, it is gentle for the skin and prevents from acarus formation at the same time. It features antibacterial properties as well.

HEALTH ALOEVERTA



Health Aloe Vera quilted cover features antiallergic and antibacterial properties. It is made of natural and specific fibers. In addition, it is moistened with the extract of aloe leaves, which support blood circulation and are gentle for the skin. It prevents from the development of acarus. And thanks to its thermal properties, it lets air run through freely.

SILVER CARE



As its name indicates, the **SilverCare** quilted cover has a silver thread inwrought, so it demonstrates higher absorption of moisture. In addition, silver thread inwrought, apart from aesthetic qualities, also demonstrates antistatic properties (removes electrostatic charge). Silver ions demonstrate antibacterial action – they neutralize acarus.

CASHMERE PRESTIGE



Cashmere Prestige cover has been made of highest grade of wool, obtained from Cashmere goats. It features great durability and lightness, it is very flexible and sensuous. It features ability to maintain warmth, providing high comfort of sleep.

BAMBOO

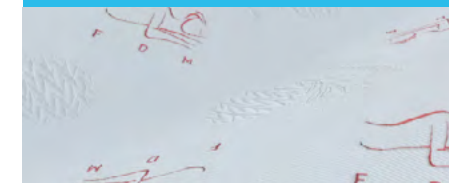

Thanks to the inset bamboo fibers, the **Bamboo** cover features many additional properties. Thanks to them, the fabric features antibacterial and thermoregulating properties, sensitive to the body temperature. It is very durable and sensuous. The cover has been equipped with a zip fastener, which allows to take it off easily and wash it in a washing machine.

EUCALYPTUS TENCEL

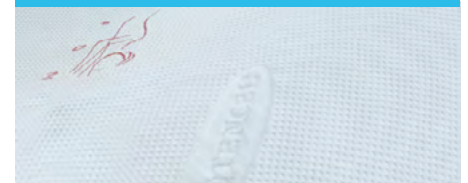

Eucalyptus Tencel cover material provides perfect ventilation, demonstrates cooling properties, and absorbs moisture thanks to microcanals. It features antibacterial properties and provides very good air circulation. The cover has been equipped with a zip fastener which allows to take it off easily and wash.



MATTRESSES CATALOGUE

DISTRIBUTOR