

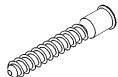









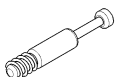











# LAR-07

## REGAŁ 3D1S

L-60 H-195 D-42

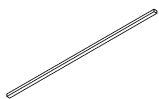

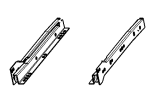
<b>x 7</b>  AKC00019	<b>x 18</b>  AKC00120	<b>x 18</b>  AKC00004	<b>x 14</b>  AKC00029	<b>x 14</b>  AKC00151	<b>x 14</b>  AKC00004	   <b>50 min</b>
<b>x 6</b>  ZAW00025	<b>x 20</b>  AKC00023	<b>x 2</b>  AKC00036	<b>x 26</b>  3.5x16 AKC00026	<b>x 15</b>  3.5x30 AKC00026	<b>x 2</b>  4x20 AKC00026	
<b>x 60</b>  AKC00018	<b>x 1</b>  AKC00153	<b>x 1</b>  AKC00017	<b>x 1</b> L-265 mm  UCH00041	<b>x 2</b> L-298 mm  UCH00042	<b>x 1</b> L-320 mm  UCH00043	<b>x 1</b> L-1026 mm  UCH00051
<b>x 4</b>  NOG00043	<b>x 1</b> L-350 mm  MEC00412					

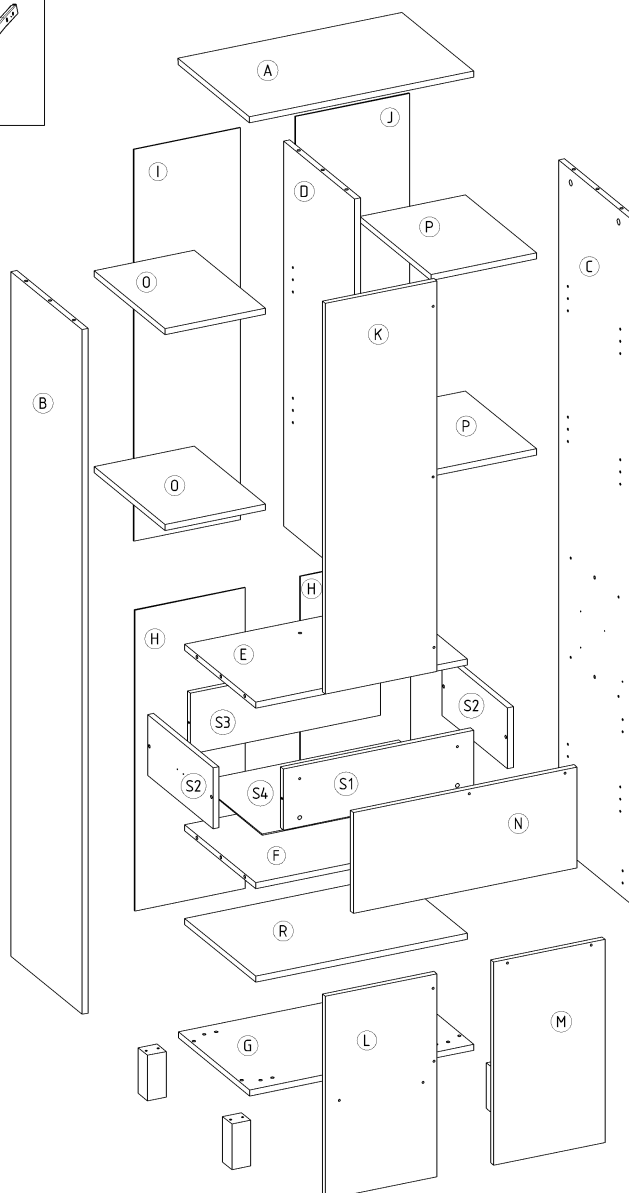

1

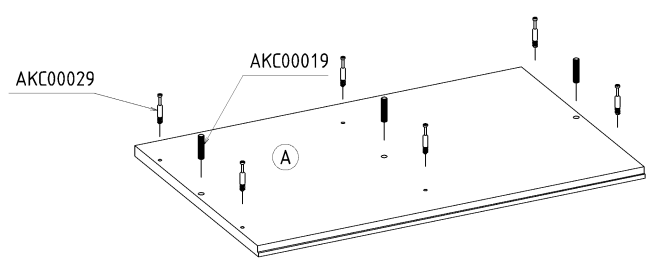

2

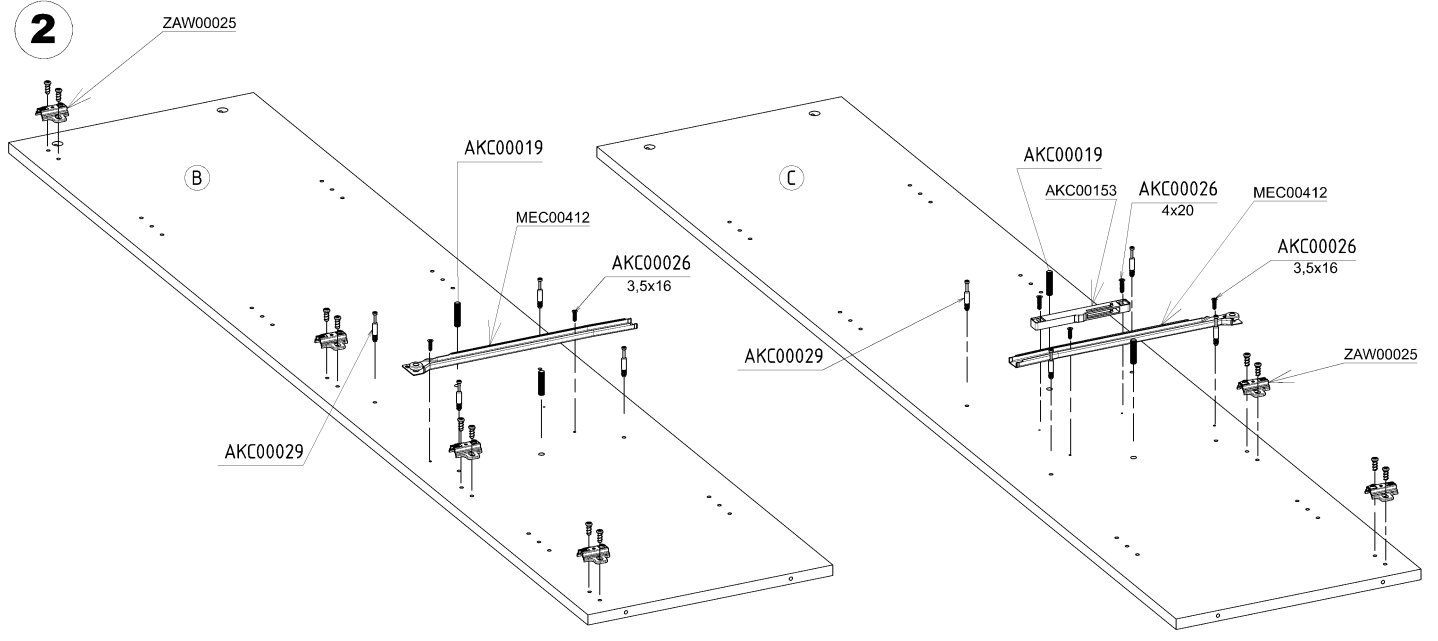

3

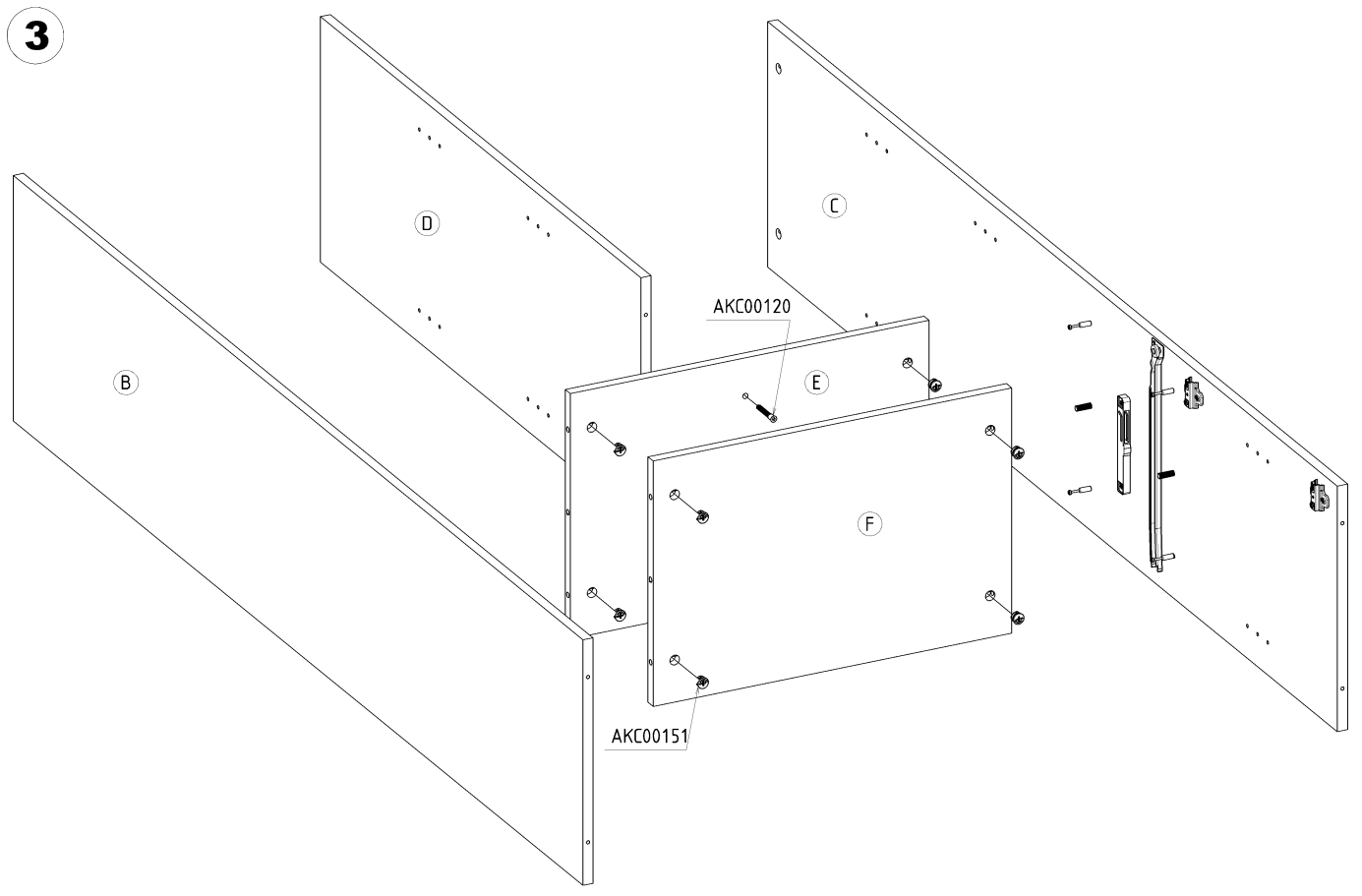

4

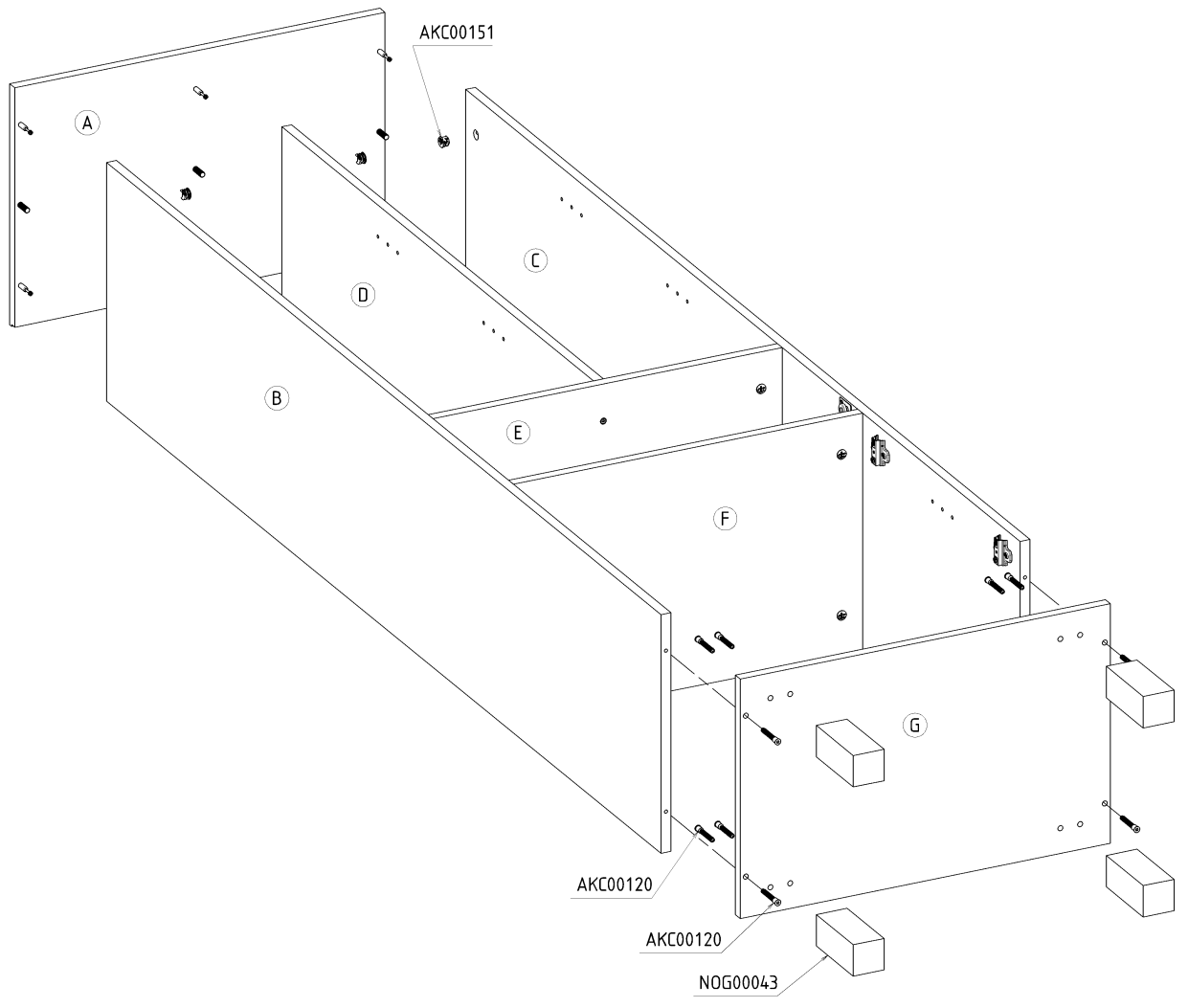

5

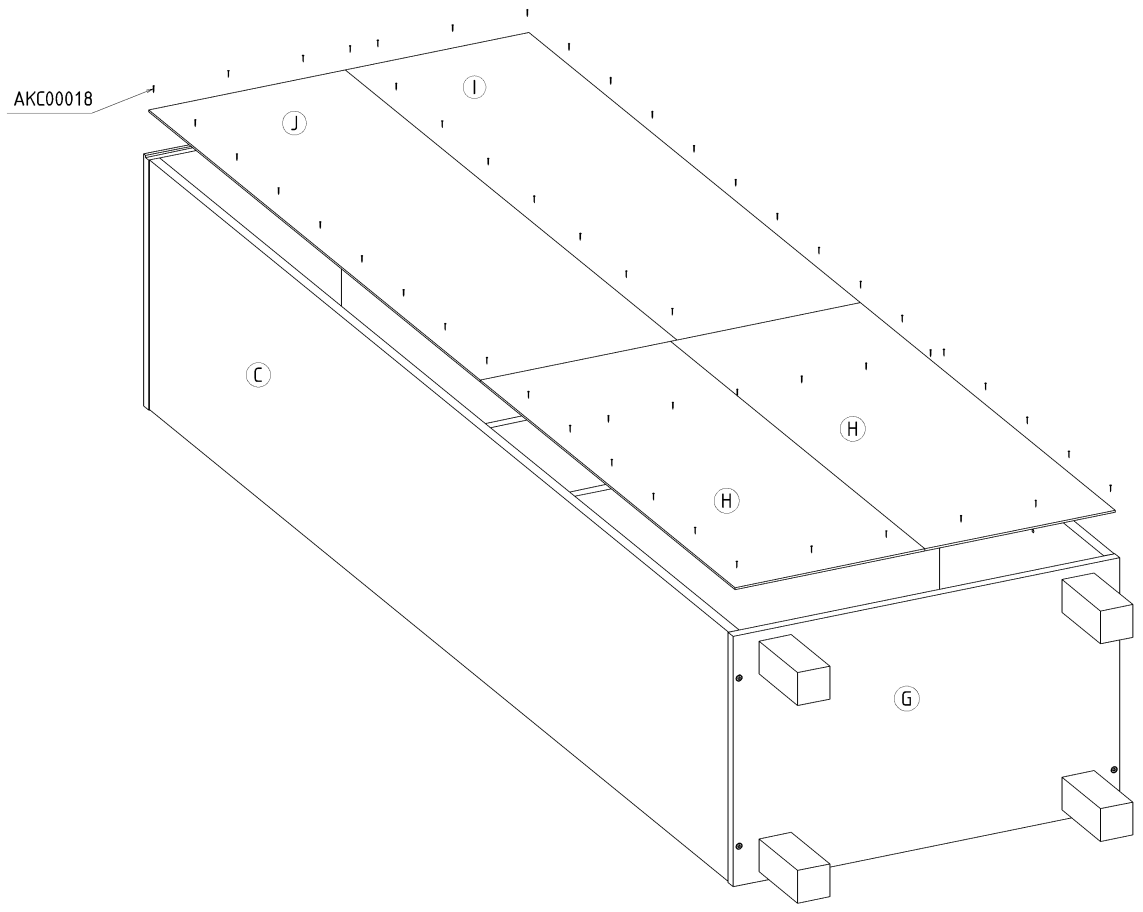

6

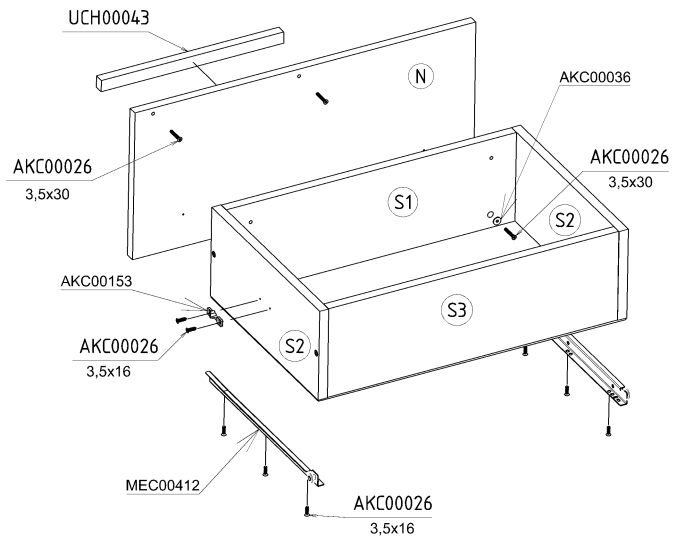
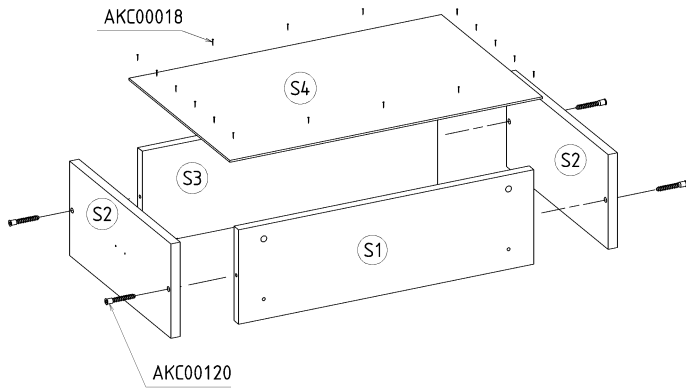

7

