

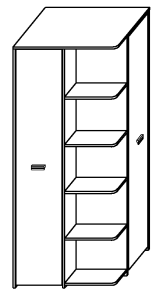

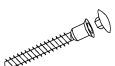







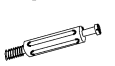

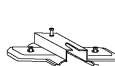
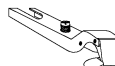

SZAFKA NAROŻNA NEMO

→ 83 ↑ 190 ↘ 63

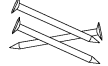
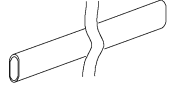
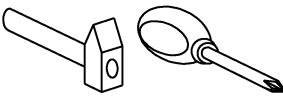

x 38  a	x 10  b	x 8  c	x 8  d	x 6  e	x 6  f
x 6  g	x 16  h	x 2  i	x 2  j	x 20 (3,5x16)  l	x 50  m
x 1 (380 mm)  k					x 1  n

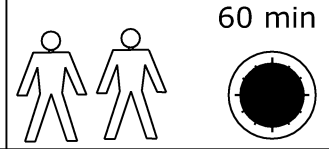

① - FAZY MONTAŻU

Ⓐ - OZNACZENIE ELEMENTÓW

Ⓐ - OZNACZENIE AKCESORIÓW

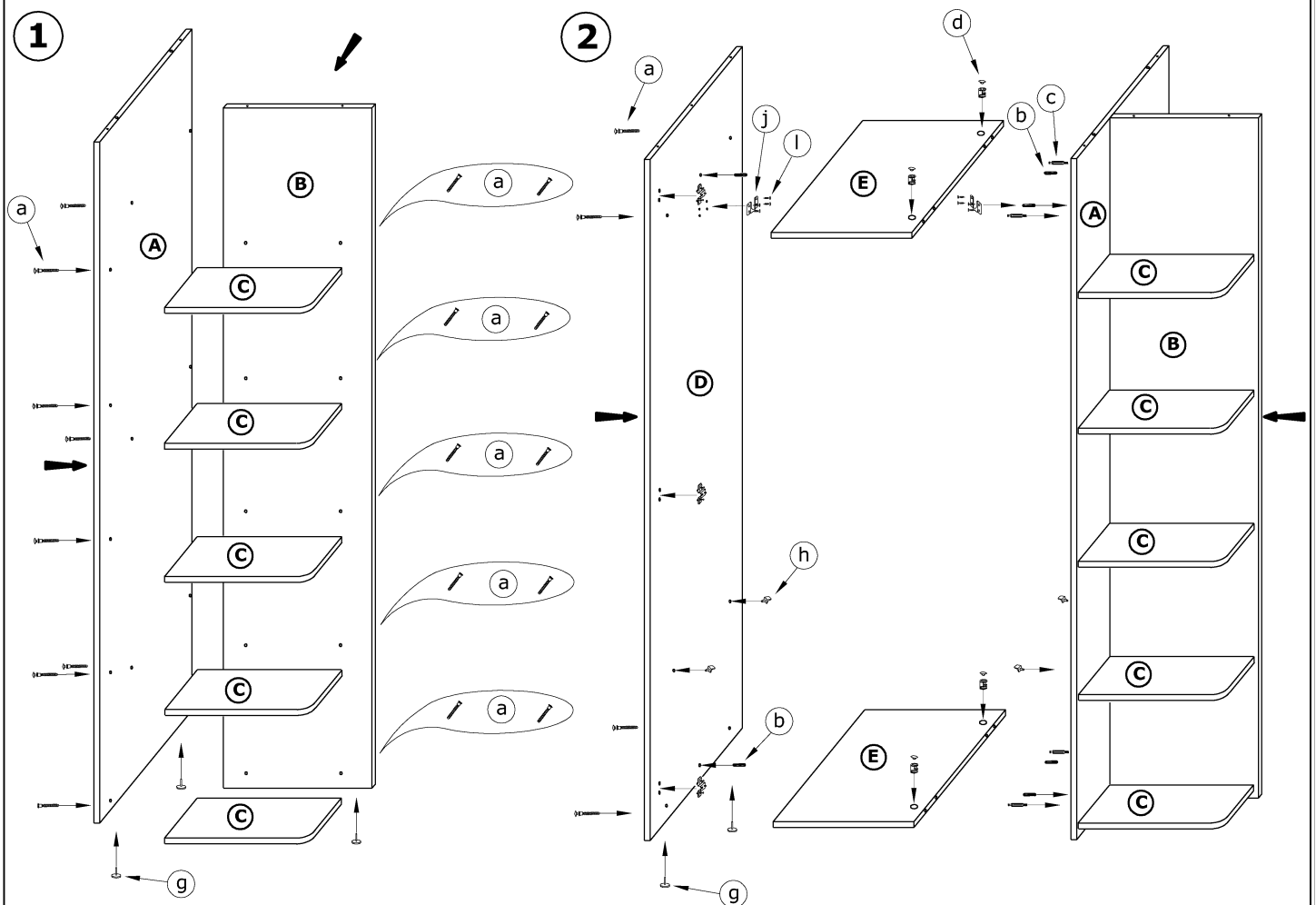

3

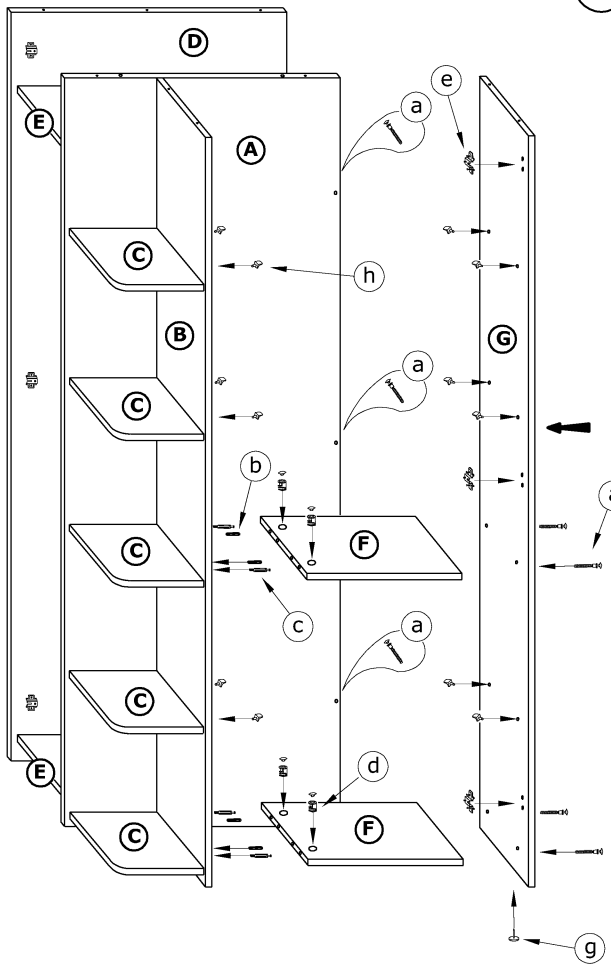

4

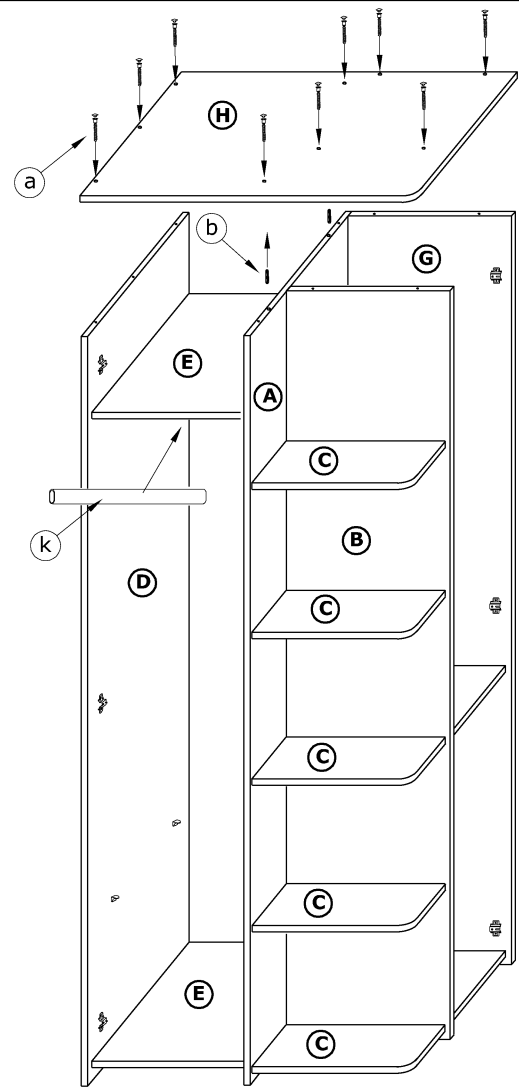

5

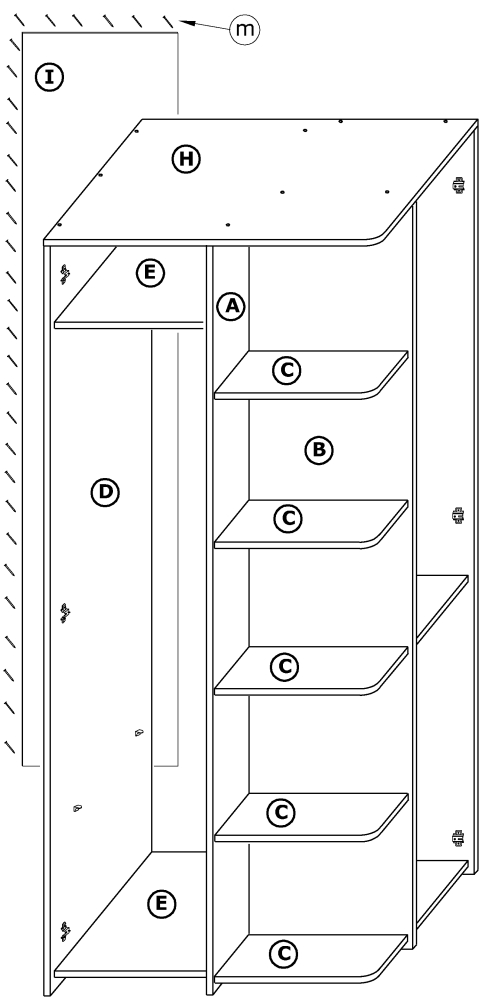

6

