

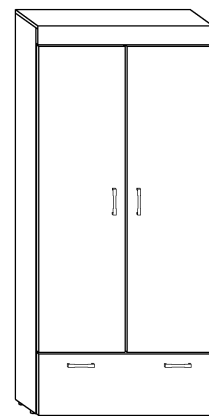

MAX - SZAFKA

→ 80 ↑ 180 ↘ 45



x 18



x 12

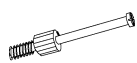

x 3

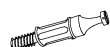

x 15



(a)

(b)

(c)

(d)

x 8

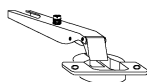

x 8

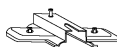

x 1

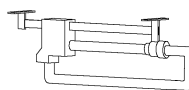

(e)

(f)

(g)

x 4

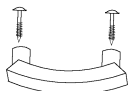

x 1

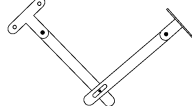

x 4

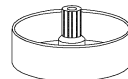

(h)

(i)

(j)

x 24 (4x16)



x 70

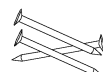

(k)

(m)



50 min



1 - FAZY MONTAŻU

A - OZNACZENIE ELEMENTÓW

a - OZNACZENIE AKCESORIÓW

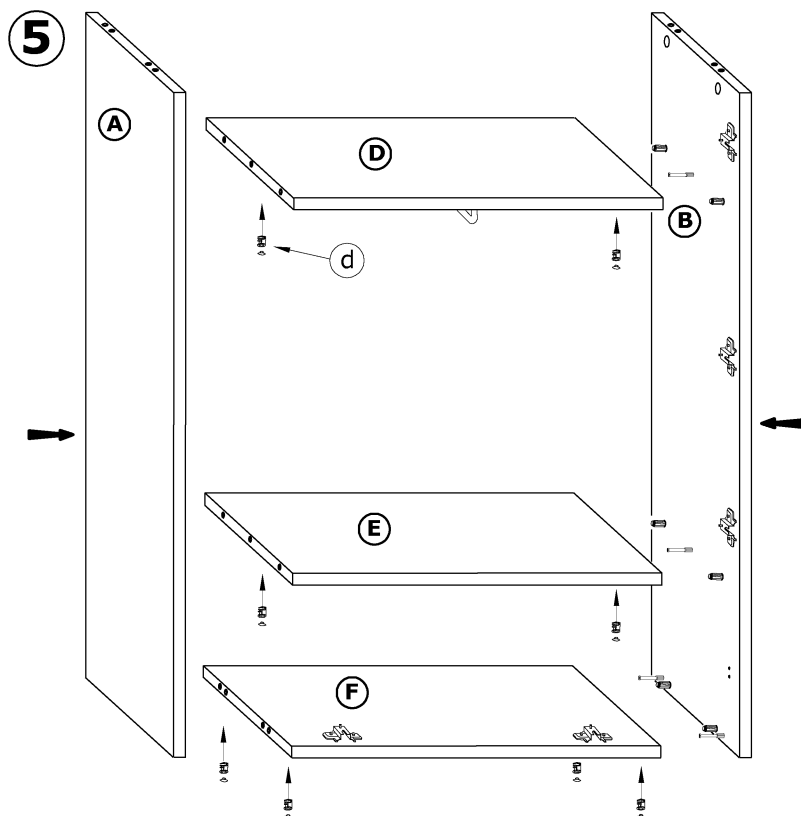
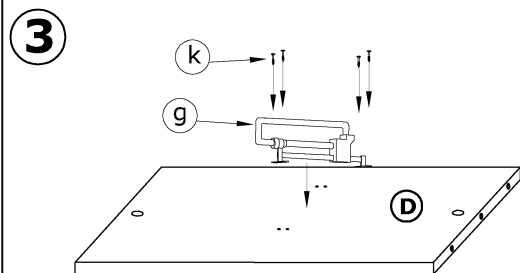
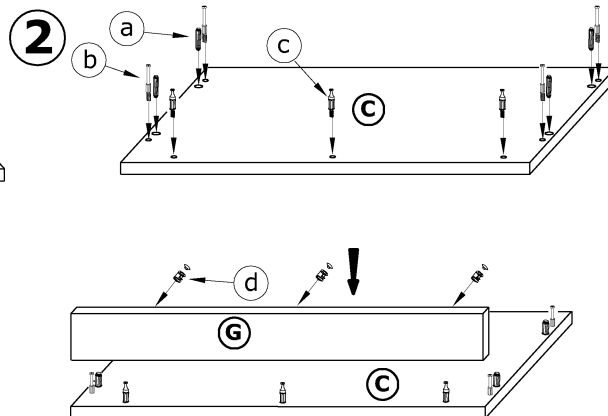
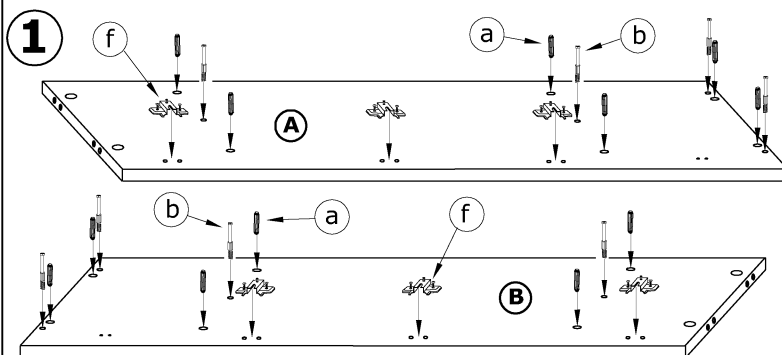

4

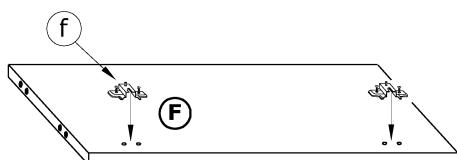

6

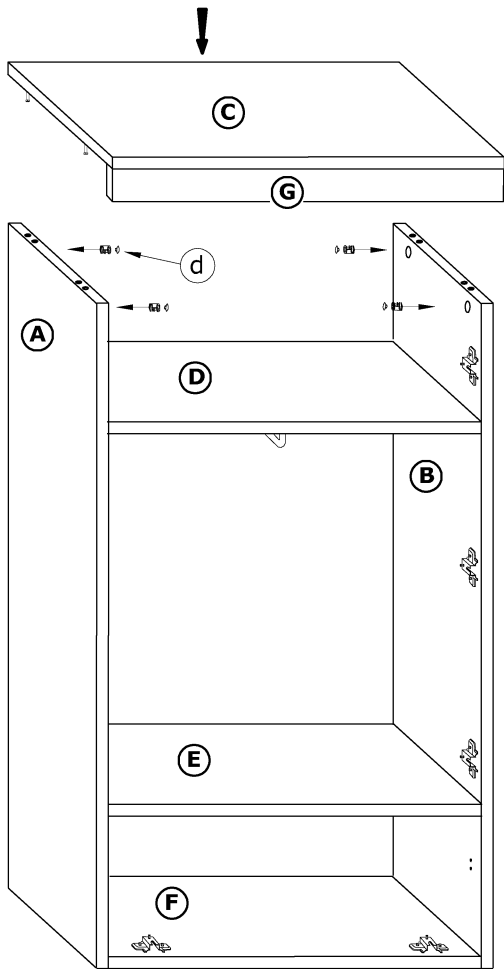

8

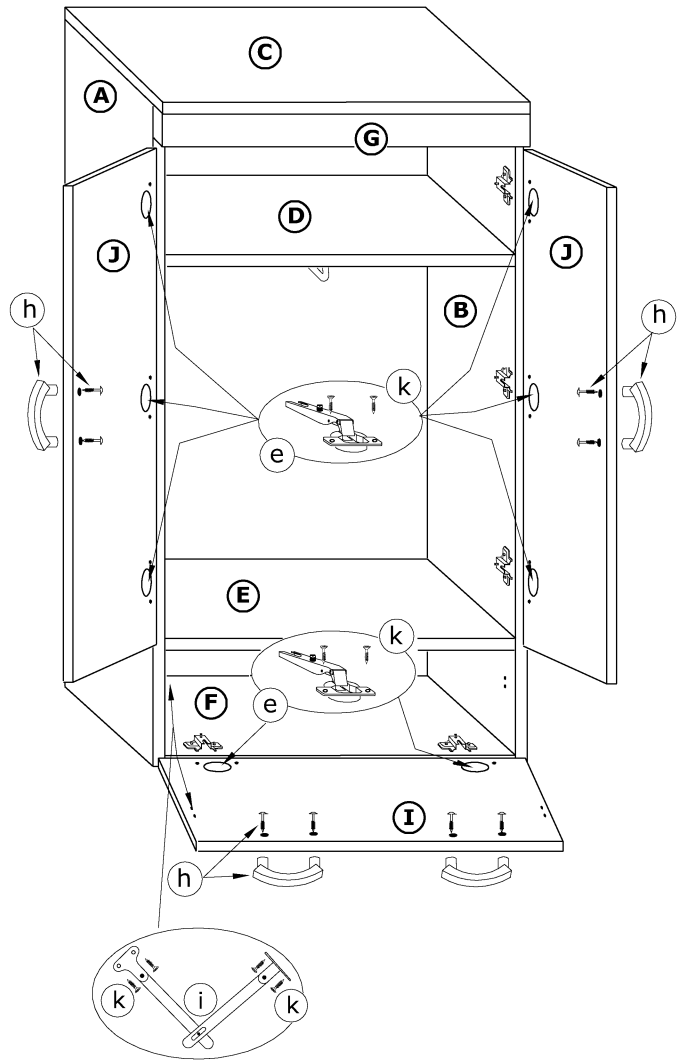

7

