

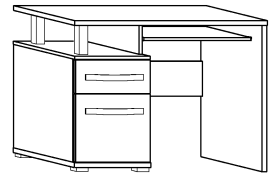

ANG-02

ANGEL- BIURKO 1D1S

-100 +77 \53



x 4 a	x 4 b	x 14 c	x 12 d	x 2 e	x 2 f	 60 min 		
x 2 g	x 2 h	x 2 kpl. (400 mm) i	x 4 j	x 2 186 mm k				
x 2 160 mm l	x 2 m	x 4 n	x 2 o					
x 26 (3,5x16) p	x 8 (4x20) r	x 4 (4x25) s	x 4 (3,5x30) t	x 2 u	x 40 w			x 1 x

① - FAZY MONTAŻU

Ⓐ - OZNACZENIE ELEMENTÓW

Ⓐ - OZNACZENIE AKCESORIÓW

1

x 4

c

x 2
186 mm

k

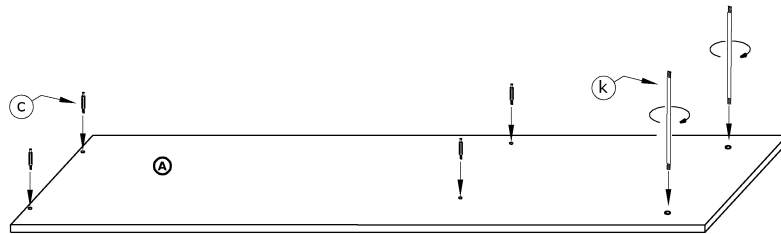

2

x 1 kpl.

i

x 6
(3,5x16)

p

x 2

o

x 2

c

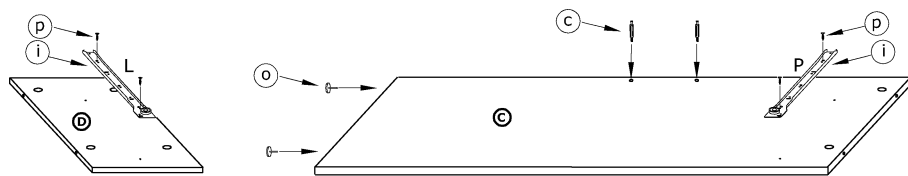

3

x 1 kpl.

i

x 6
(3,5x16)

p

x 2

f

x 4

n

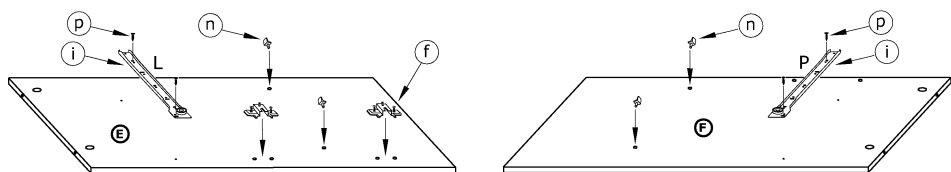



4

x 4

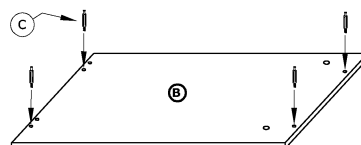
c







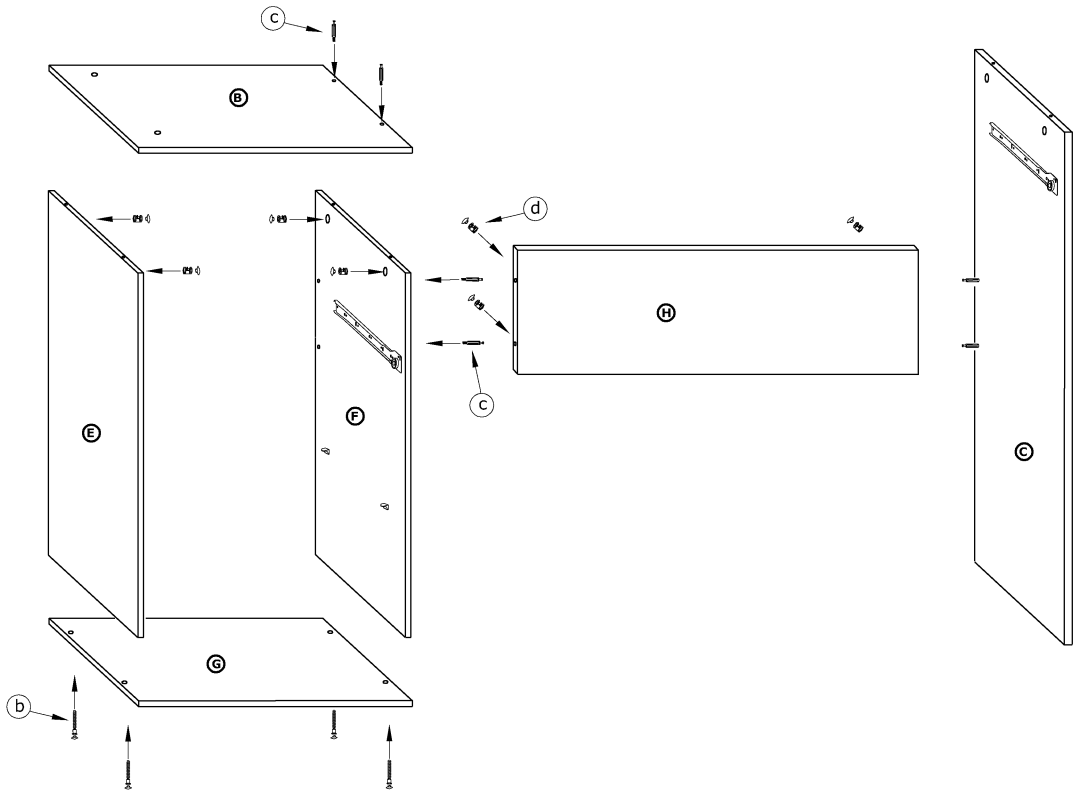

5

- x 4

- x 4

- x 8



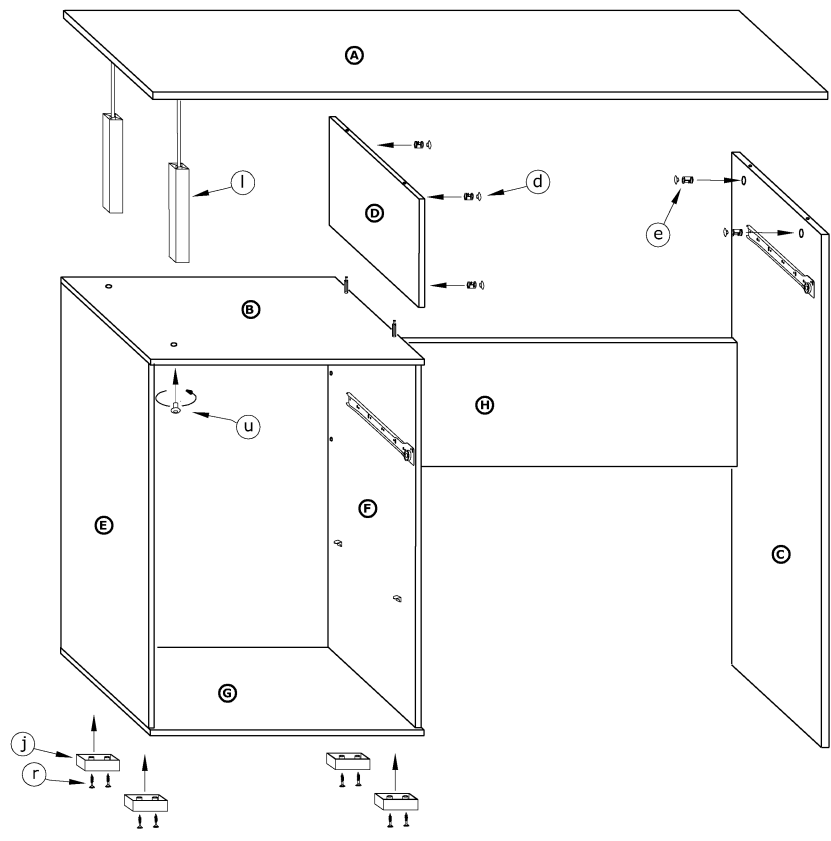







6

- x 4

- x 2

- x 2 160 mm

- x 4

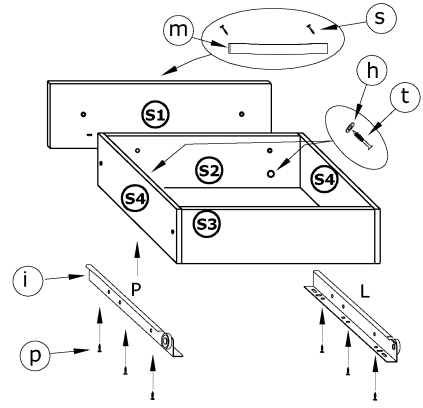
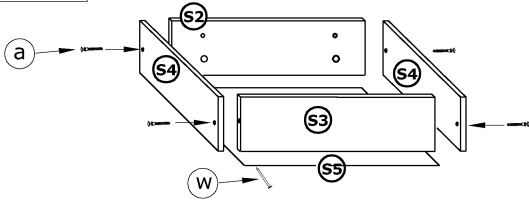
- x 8 (4x20)

- x 2





7

- x 4 (a) 
- x 1 (i) 
- x 1 (m) 
- x 6 (3,5x16) (p) 
- x 2 (4x25) (s) 
- x 2 (3,5x30) (t) 
- x 2 (h) 
- x 15 (w) 





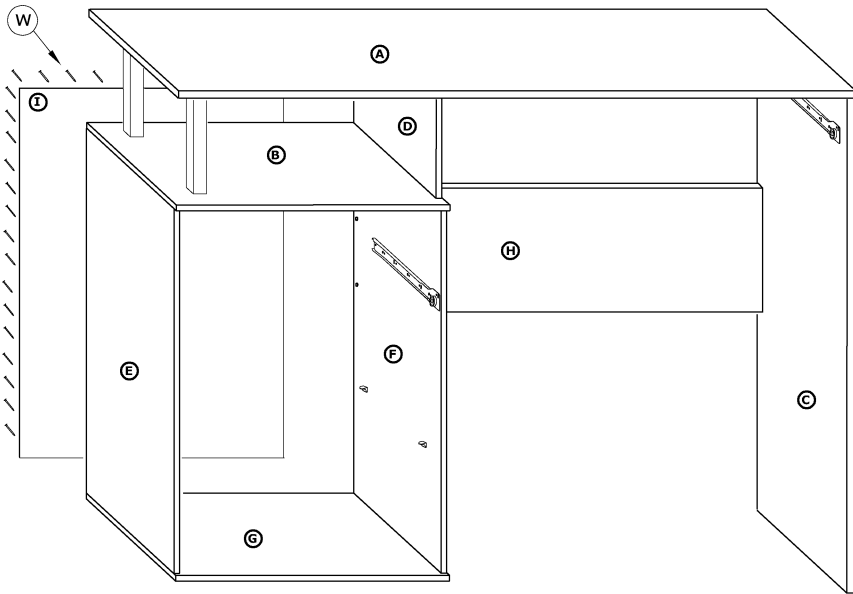

8

- x 25 (w) 



9

- x 2 (g) 
- x 1 (i) 
- x 1 (m) 
- x 10 (3,5x16) (p) 
- x 2 (4x25) (s) 
- x 2 (3,5x30) (t) 