

1 ŁĄCZENIE SZAFEK 2

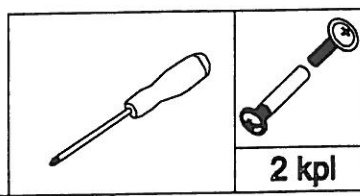

INSTRUKCJA MONTAŻU

MODEL G60 2D
MODEL G80 2D

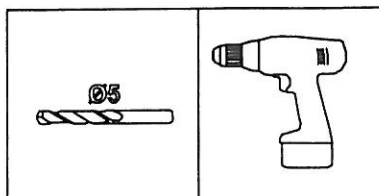
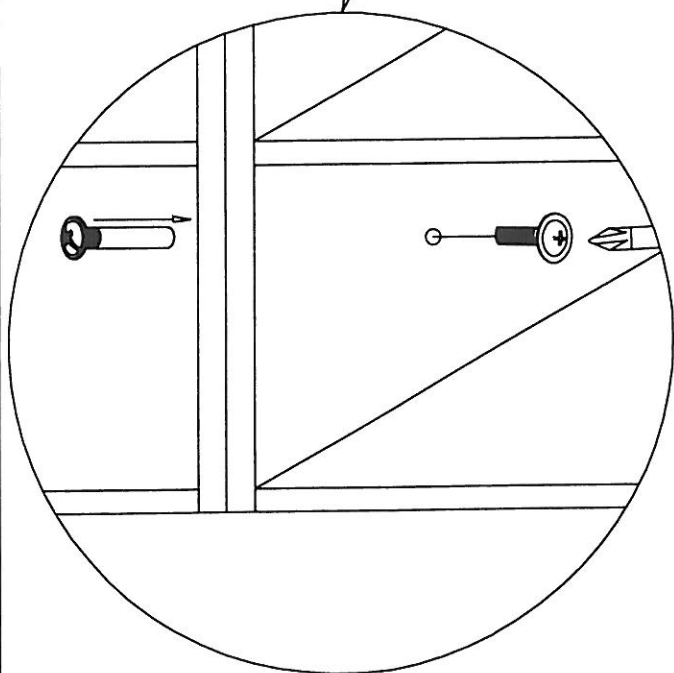
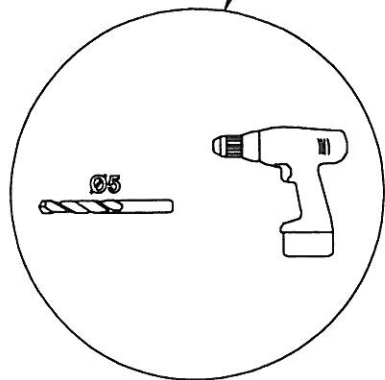
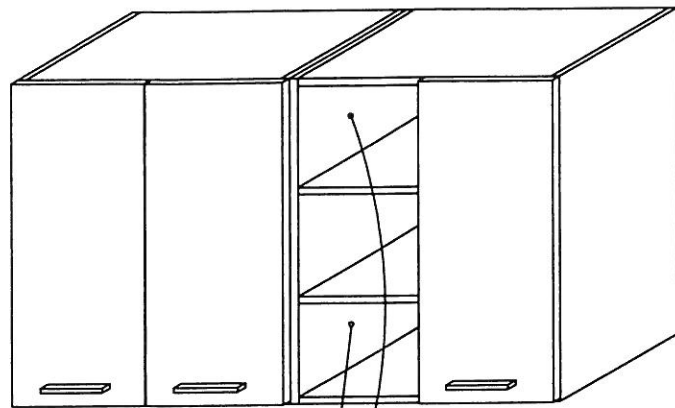
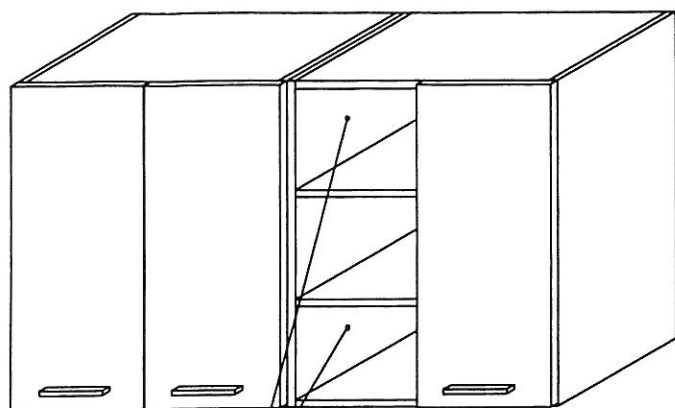
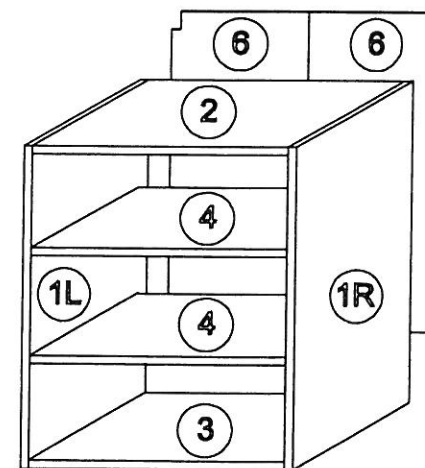
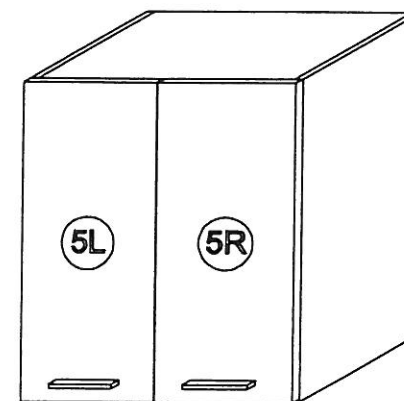

PRZED MONTAŻEM
NALEŻY ZAPOZNAĆ SIĘ Z
INSTRUKCJĄ

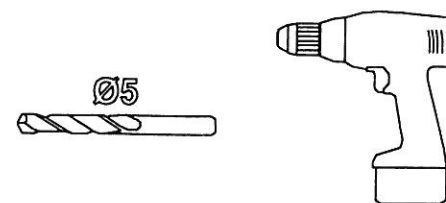
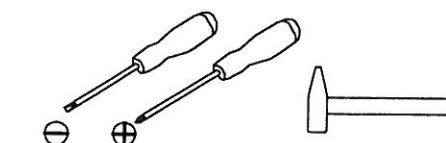
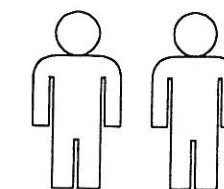
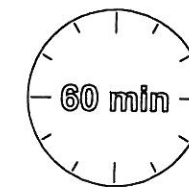

| Ø8 x 35 | | | | | Ø7 x 50 | | Ø3.5 x 16 | | | |
|---------|-------|-------|-------|--------|---------|--------|-----------|-------|-------|-------|
| | | | | | | | | | | |
| 12 szt | 8 szt | 4 szt | 4 szt | 20 szt | 8 szt | 16 szt | 2 kpl | 1 szt | 2 kpl | 1 szt |

