

A	B	C	D
1	MZ1-579	305x85	1/1
2	MZ1-580	305x85	1/1
3	S19-1324A	468x380	1/1
4	S19-5571	337x85	1/1
5	S19-546	468x369	1/1
6	S19-903	348x301	1/1
7	S363-007	365x94	1/1
8	S363-008	365x182	1/1
9	S363-209	402x385	1/1
10	S363-210	402x385	1/1
11	S363-517	337x79	1/1

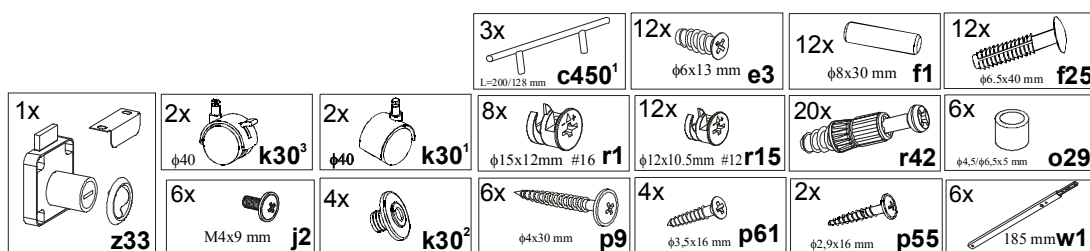

1

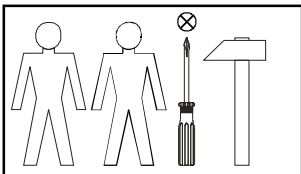
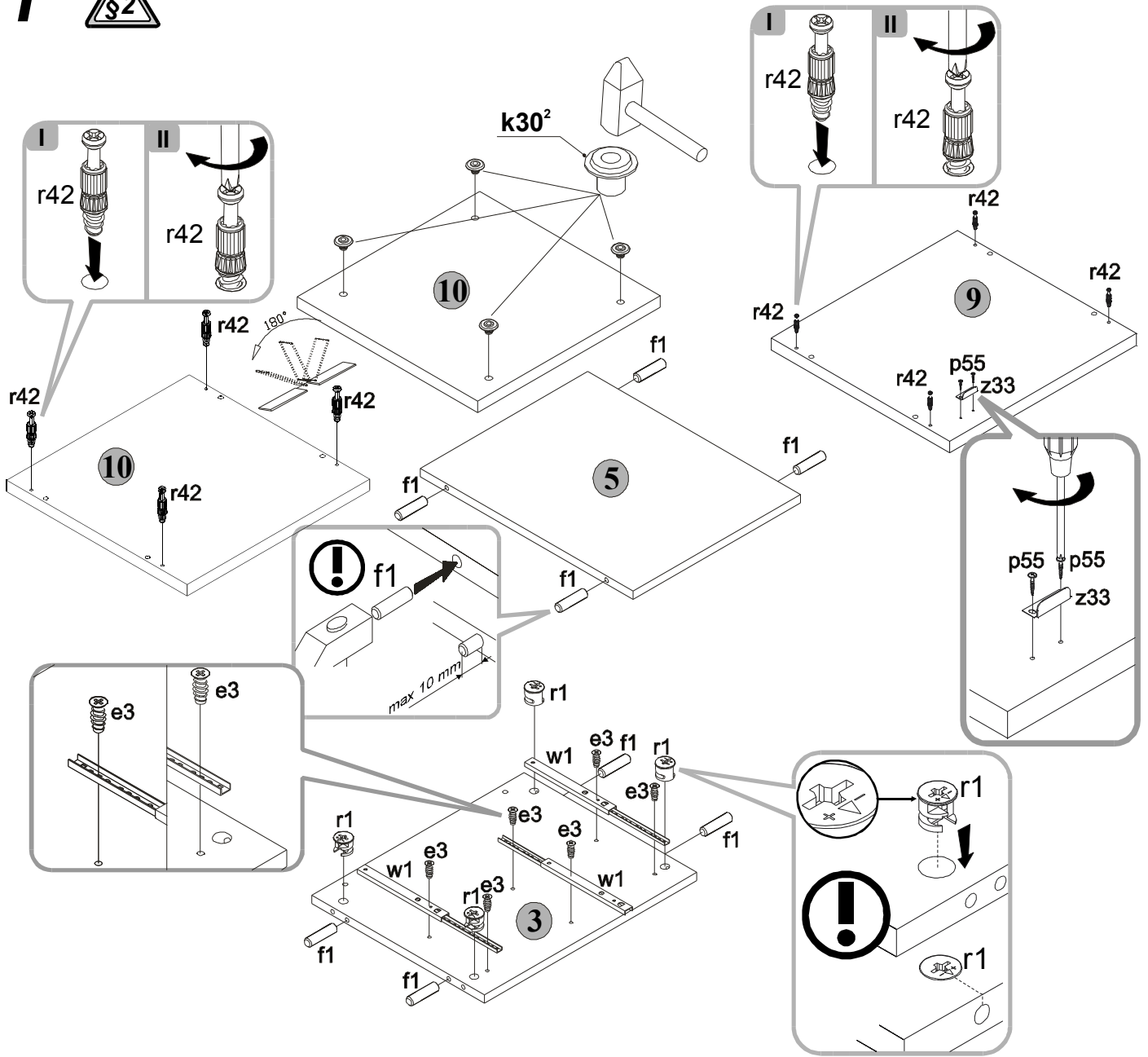

2

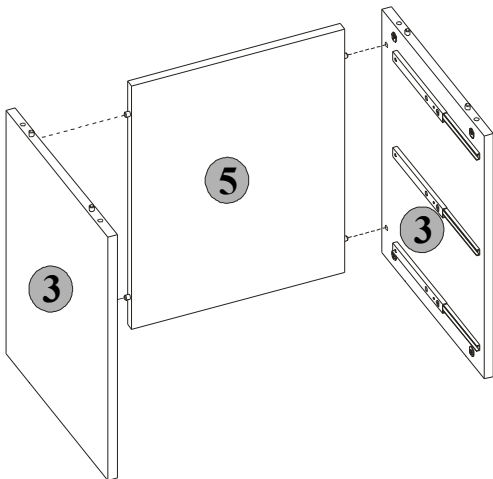

3

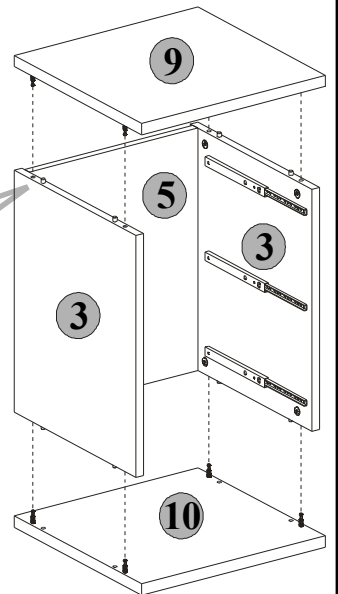
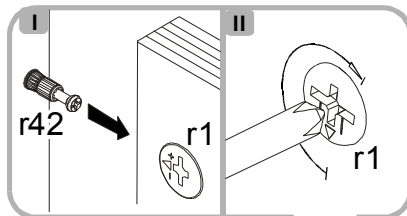

4

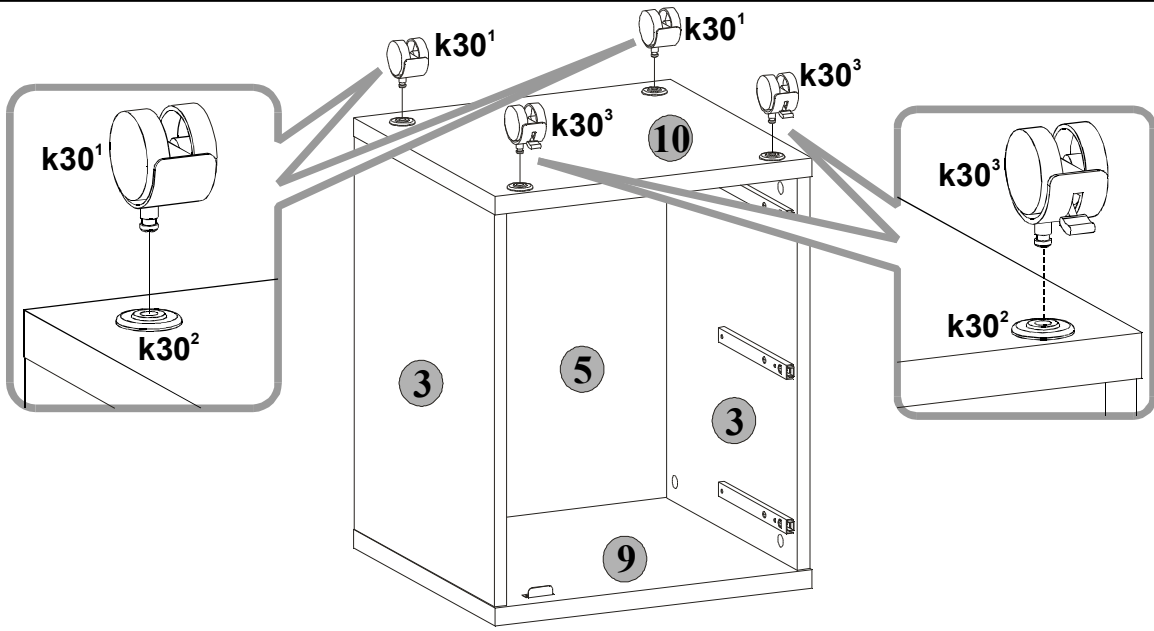

5

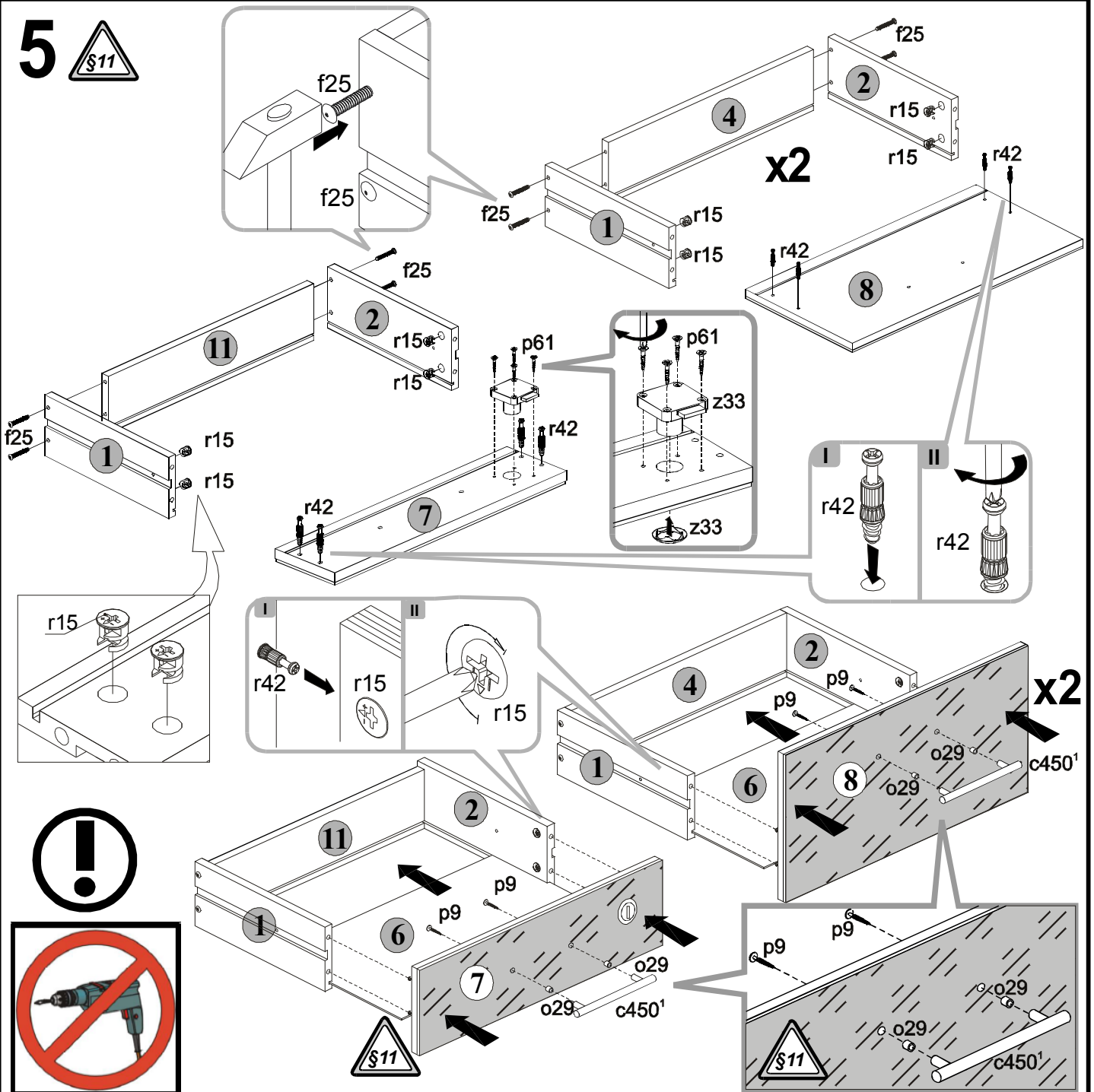

6

