

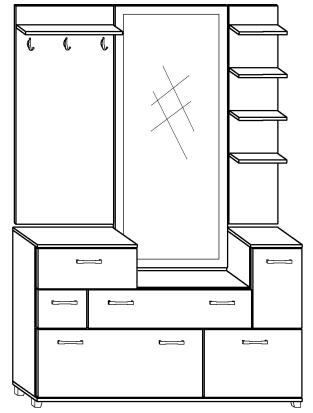









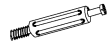





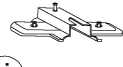

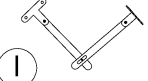
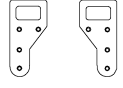

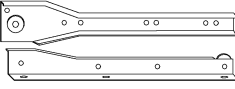

GRAND

→ 130 + 190 ↘ 38



x 33  a	x 3  b	x 14  c	x 14  d	x 8  e	x 8  f	
x 4  g	x 2  h	x 4  i	x 10  j	x 2  k	x 3  l	
x 3 kpl.  m	x 3  o	x 4 (3,5x30)  r	x 54 (3,5x16)  s	x 24 (3x13)  t	x 100  u	x 1  w
x 1 (300 mm - kpl.)  n	x 5  p					

1 - FAZY MONTAŻU

A - OZNACZENIE ELEMENTÓW

a - OZNACZENIE AKCESORIÓW

1

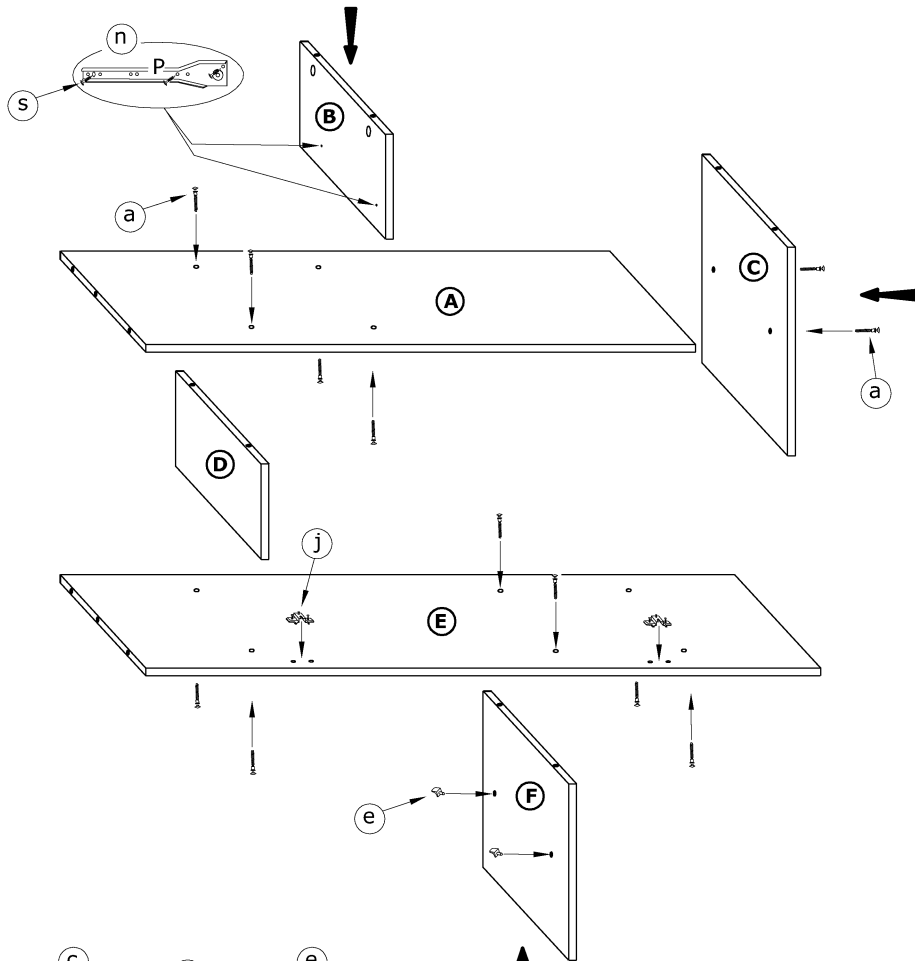

2

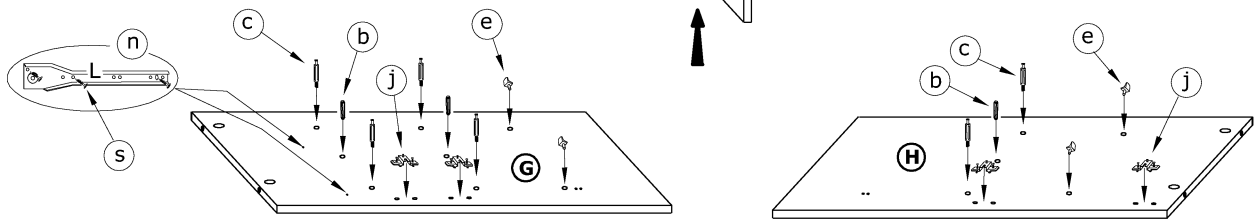

3

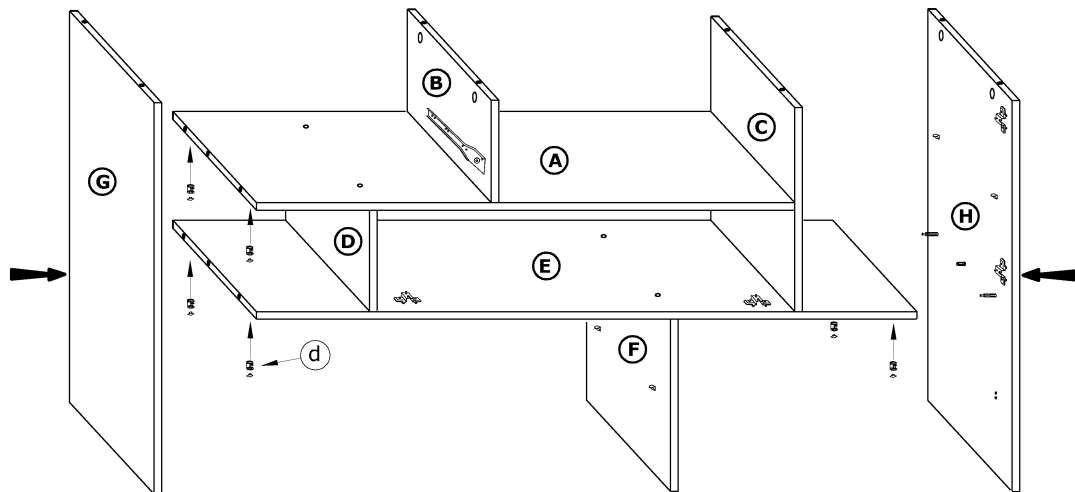

4

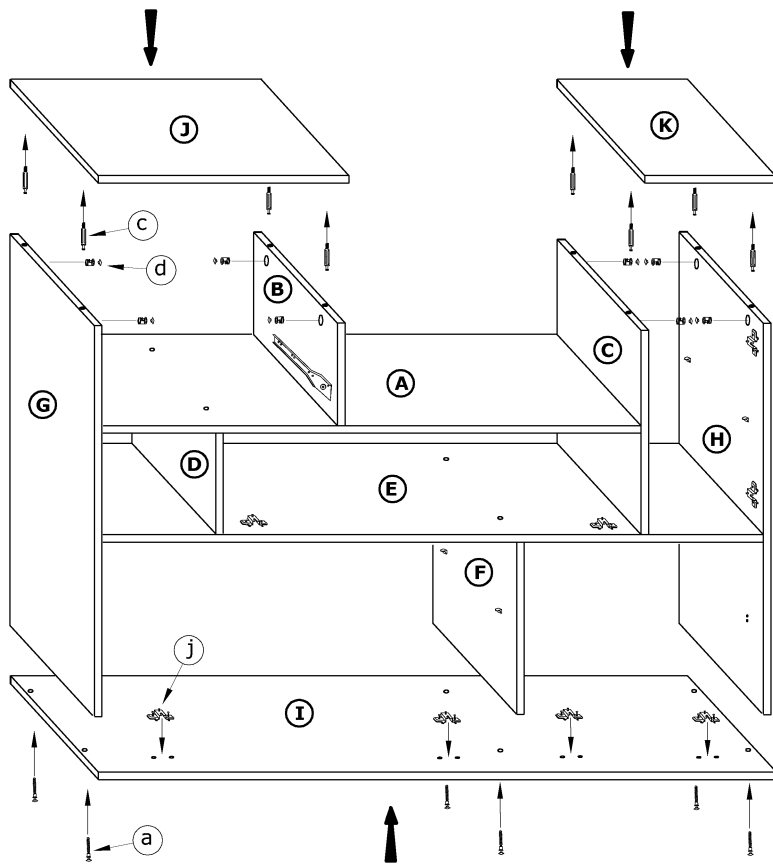

5

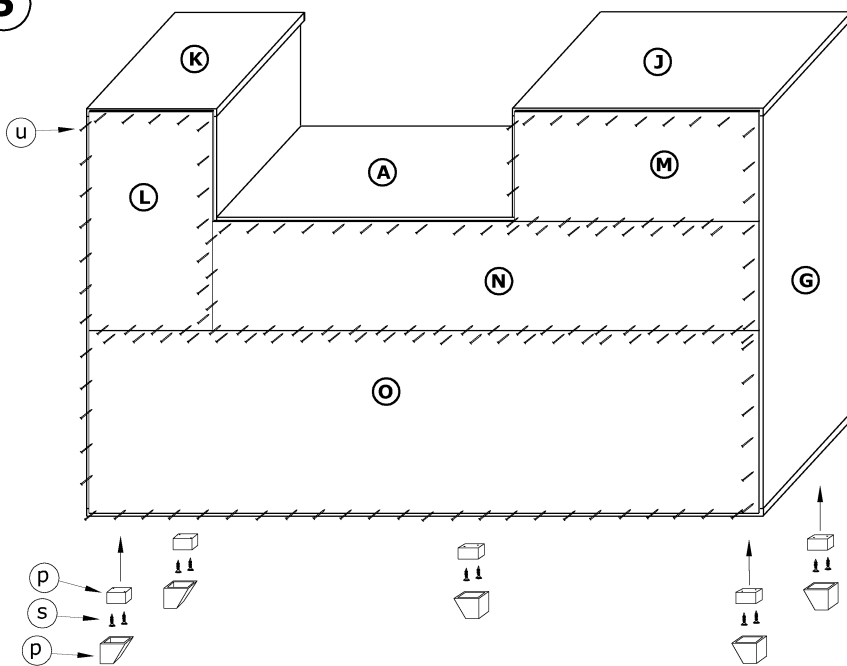

6

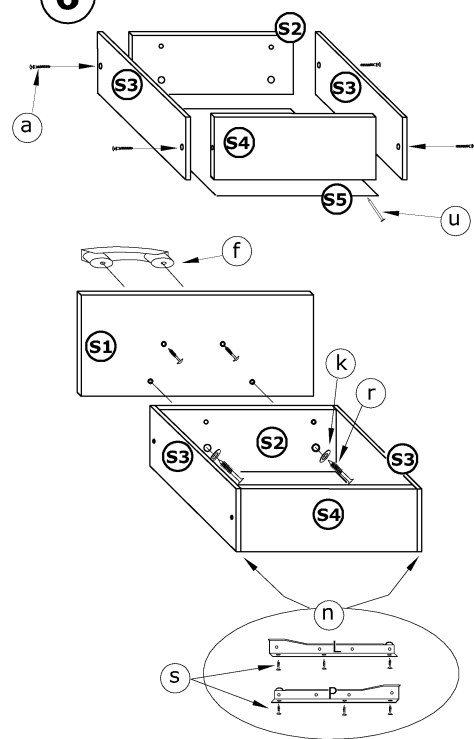

7

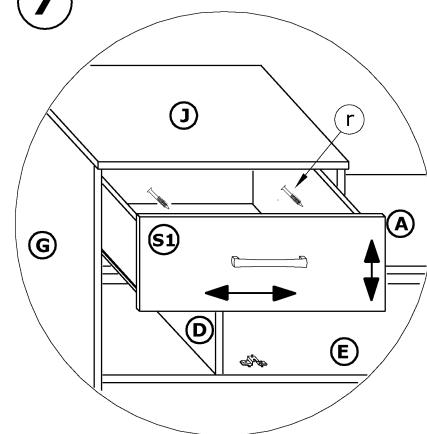

8

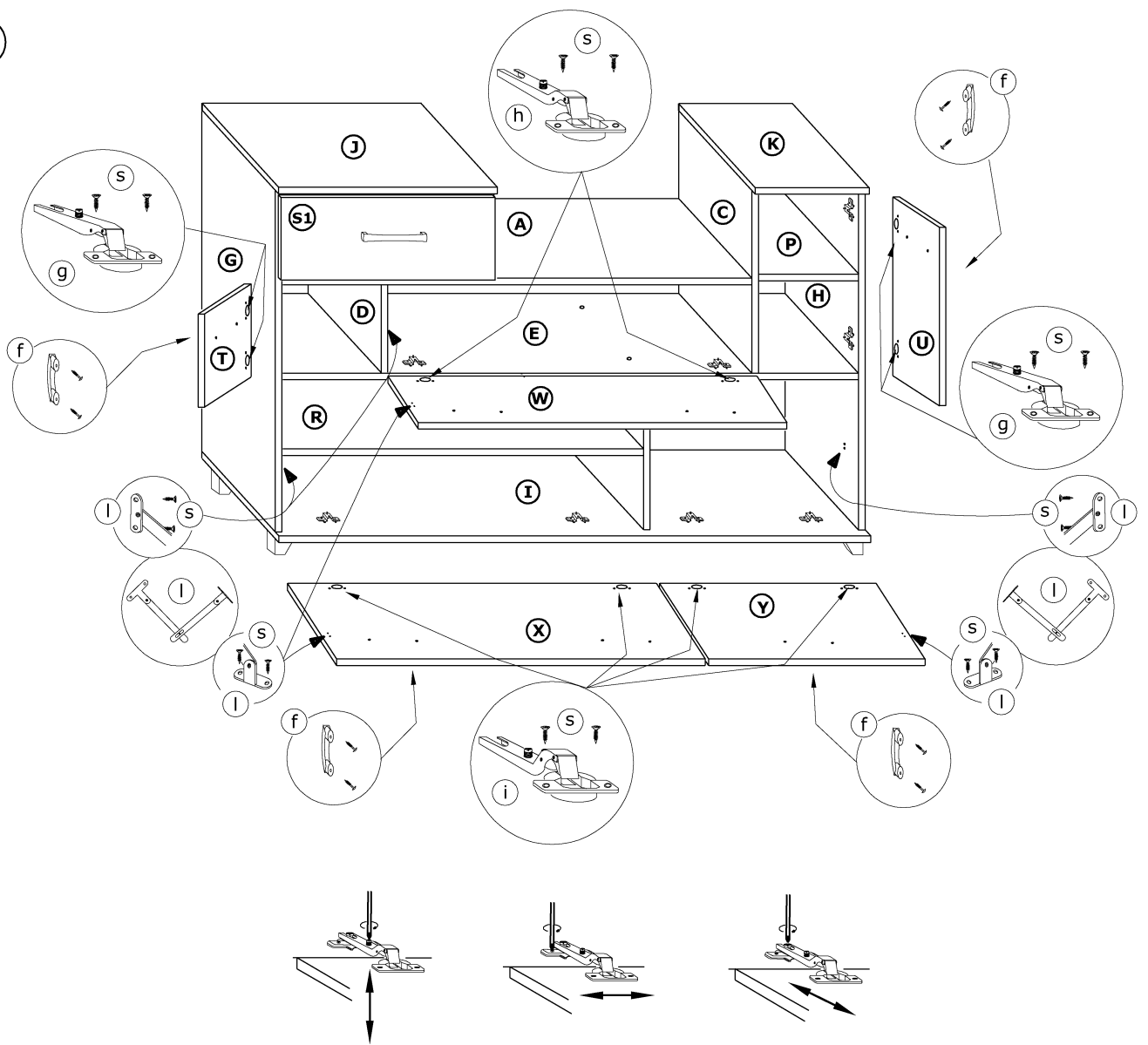

9

