

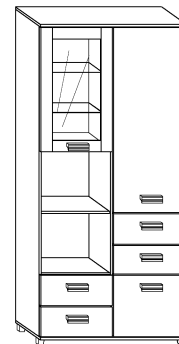

SOL-05 SOLO - REGAŁ

→ 90 ↑ 200 ↘ 42



x 28



(a)

x 6



(b)

x 12

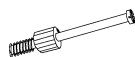

(c)

x 12



(d)

x 7

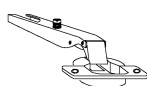

(e)

x 7

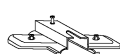

(f)

x 4 kpl. (350 mm)

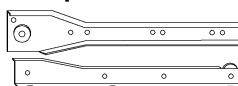

(g)

x 7



(h)

x 20



(i)

x 8



(j)

x 72 (4x16)



(k)

60 min

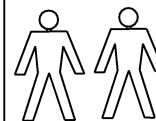

x 16 (3,5x30)



(l)

x 5

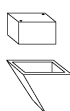

(m)

x 140



(n)

x 1



(o)

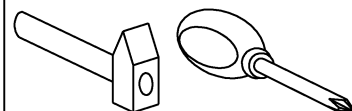

1 - FAZY MONTAŻU

A - OZNACZENIE ELEMENTÓW

a - OZNACZENIE AKCESORIÓW

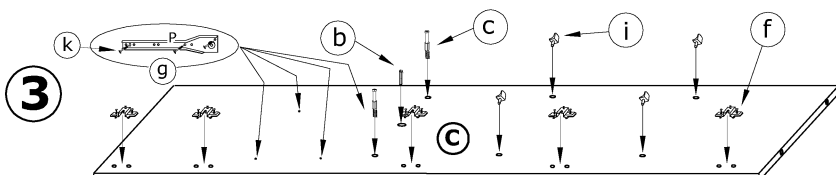
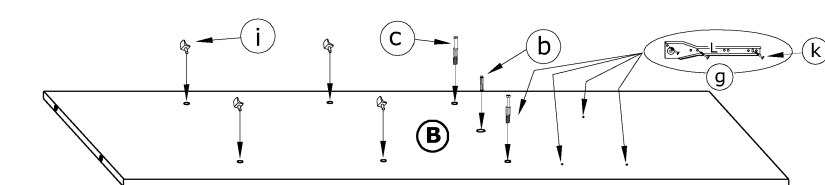
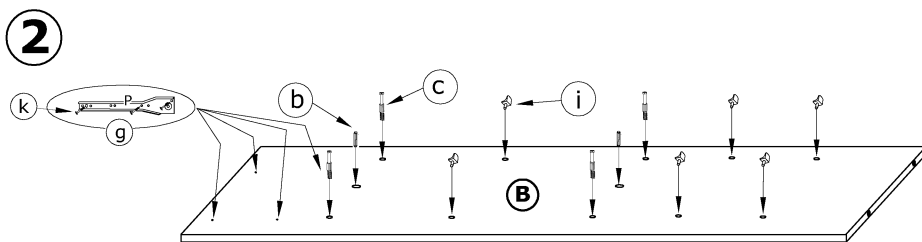
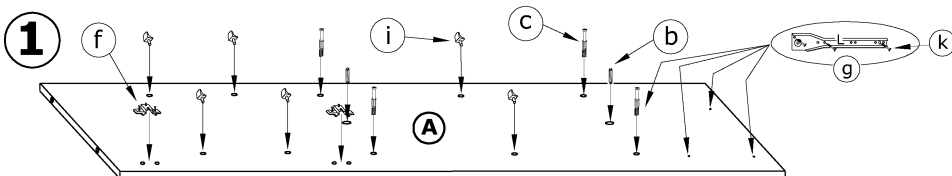

X 4

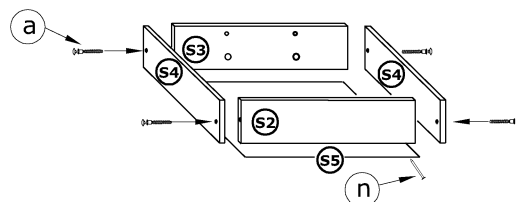

X 4

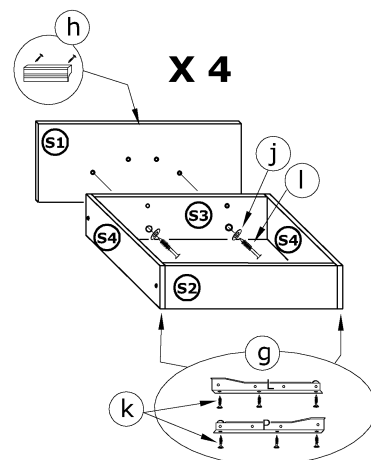

4

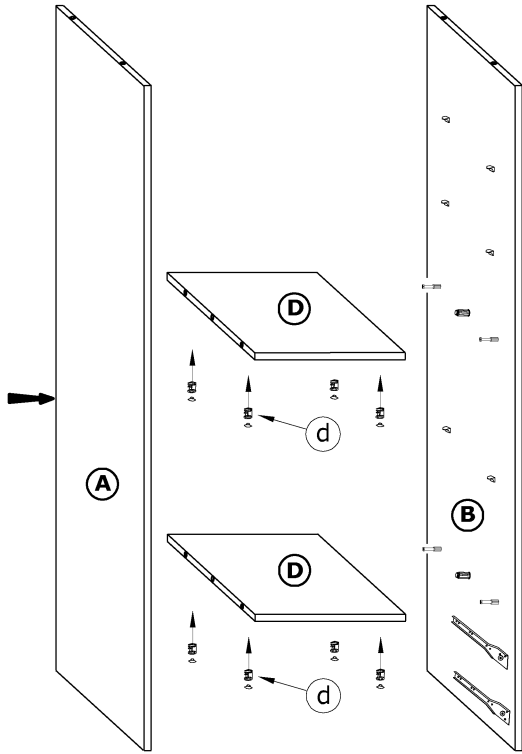

5

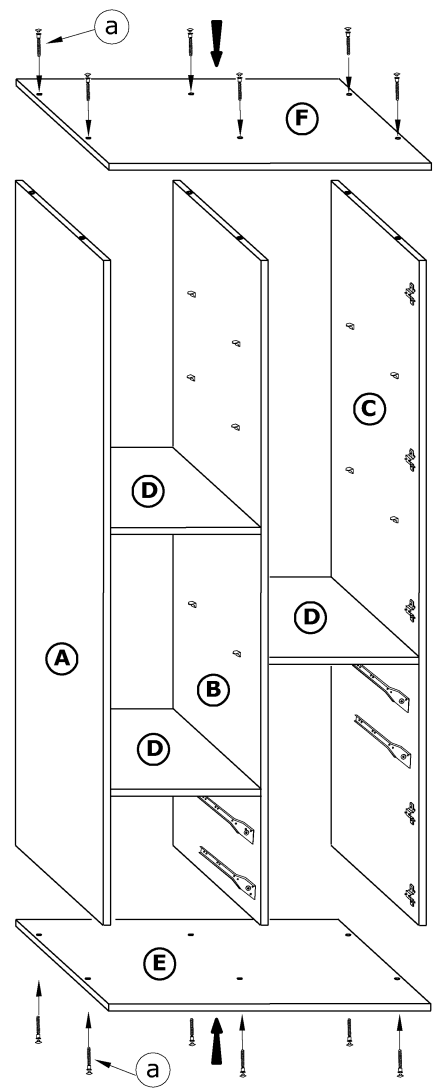

6

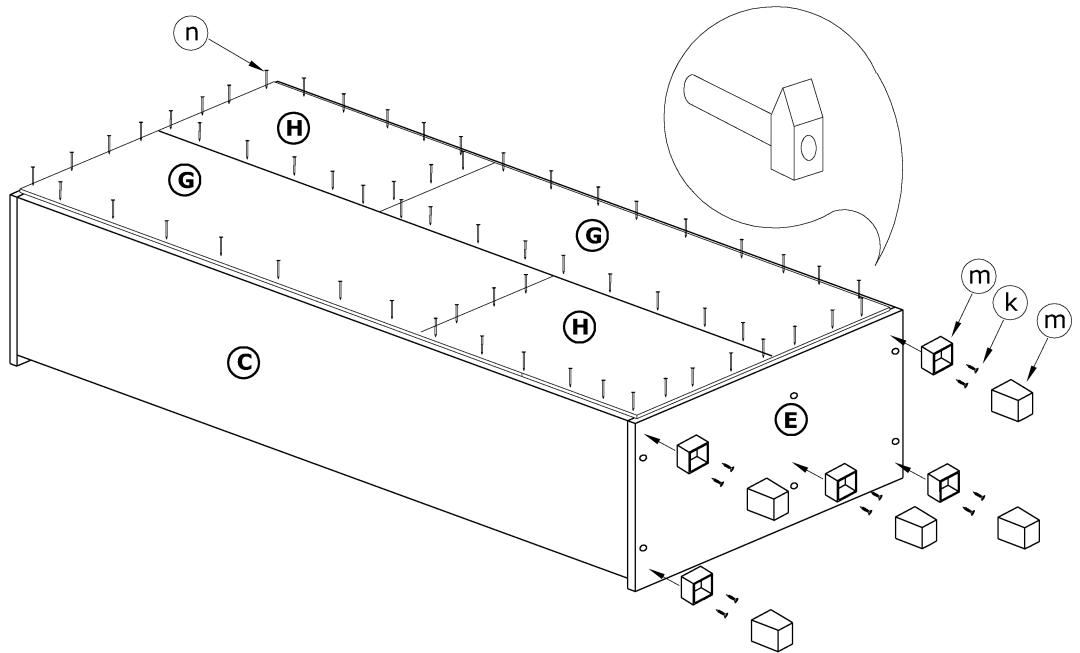

7

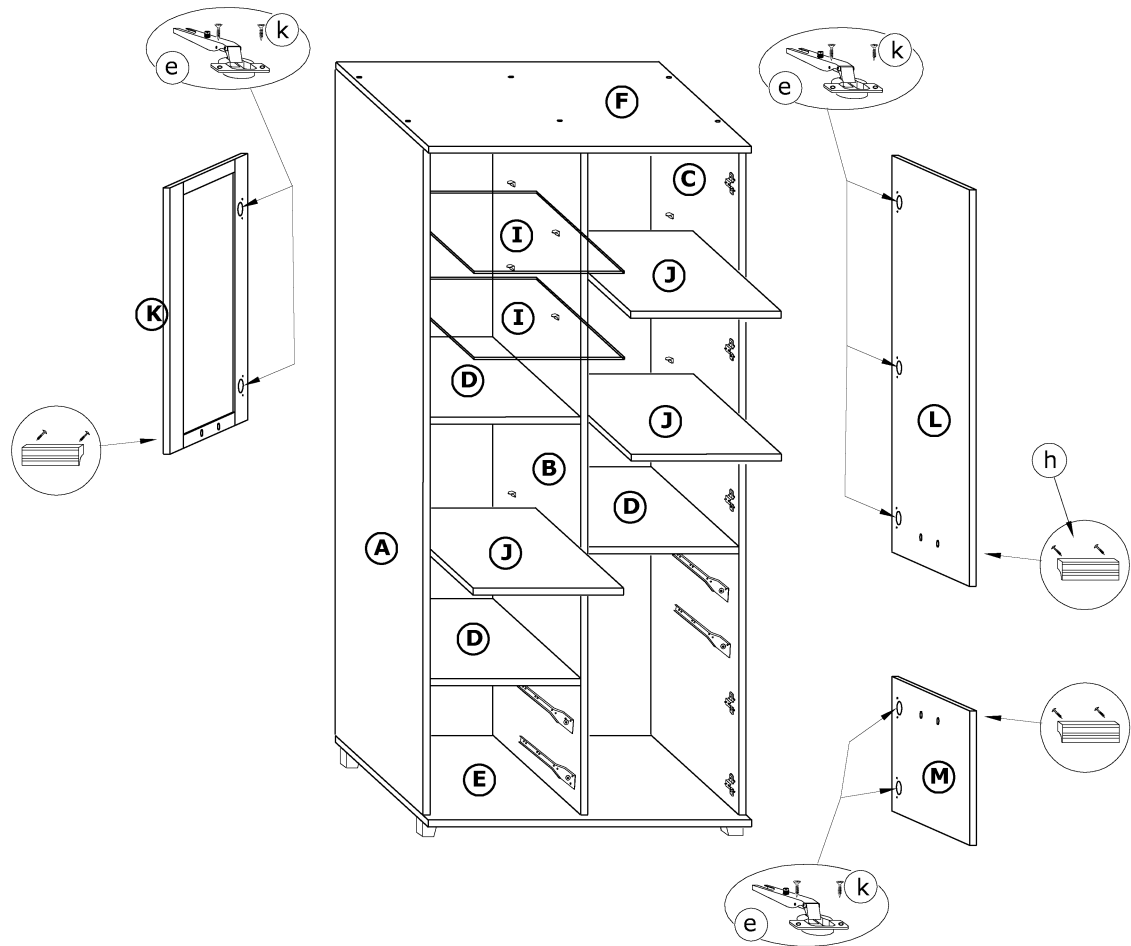

8

