

Szafa 120

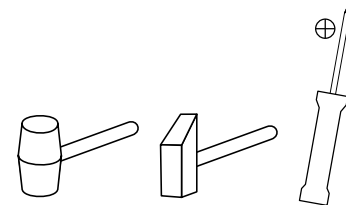

Nr	Nazwa elementu	D[mm]	S[mm]	G[mm]	Ilość
1	Bok L	2150	610	16	1
2	Bok P	2150	610	16	1
3	Wieniec Górny	1168	593	16	1
4	Wieniec Dolny	1168	610	16	1
5	Przegroda Pionowa	1676	470	16	1
6	Przegroda Mała	326	470	16	1
7	Przegroda Pozioma	1168	470	16	1
8	Półka	470	450	16	3
9	Cokół	1168	100	16	1
10	Listwa Maskująca	1168	70	16	1
11	Kapak	2015	592	2,5	2
12	Drzwi L	2005	600	16	1
13	Drzwi P	2005	600	16	1

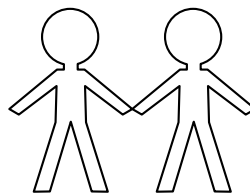
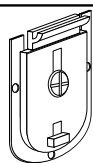
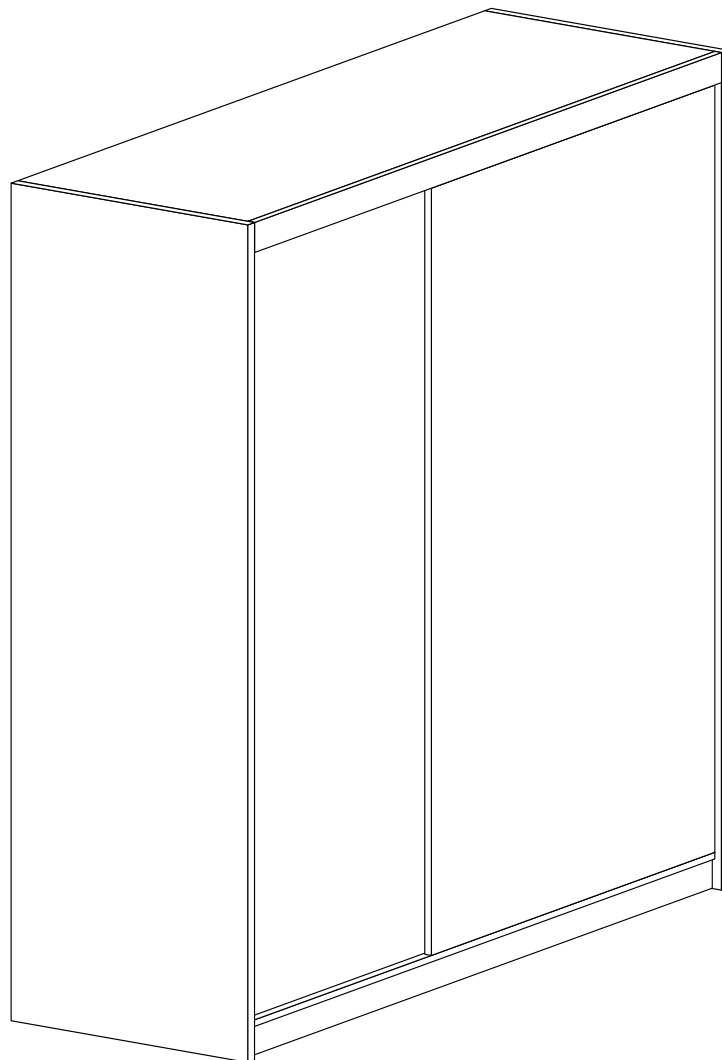

A - 4 St.

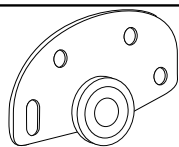

B - 4 St.

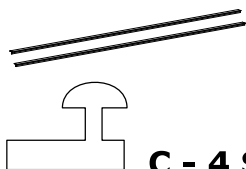

C - 4 St.

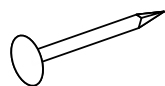

D - 100 St.

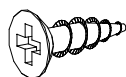

E - 16 St.
2,5x10 mm



F - 28 St.
3,5x16 mm



G - 4 St.
3,5x16 mm

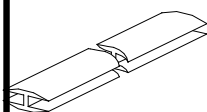

H - 1 St.



I - 21 St.



J - 16 St.

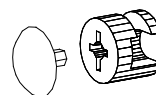

K - 3 St.

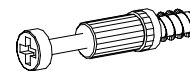

L - 3 St.

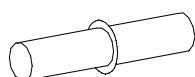

M - 12 St.

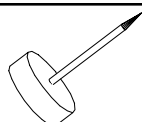

N - 8 St.



O - 1 St.

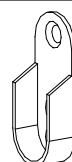

P - 2 St.



R - 4 St.

I

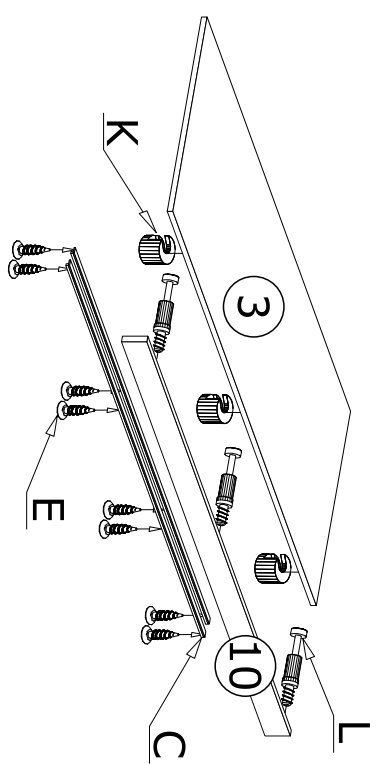

II

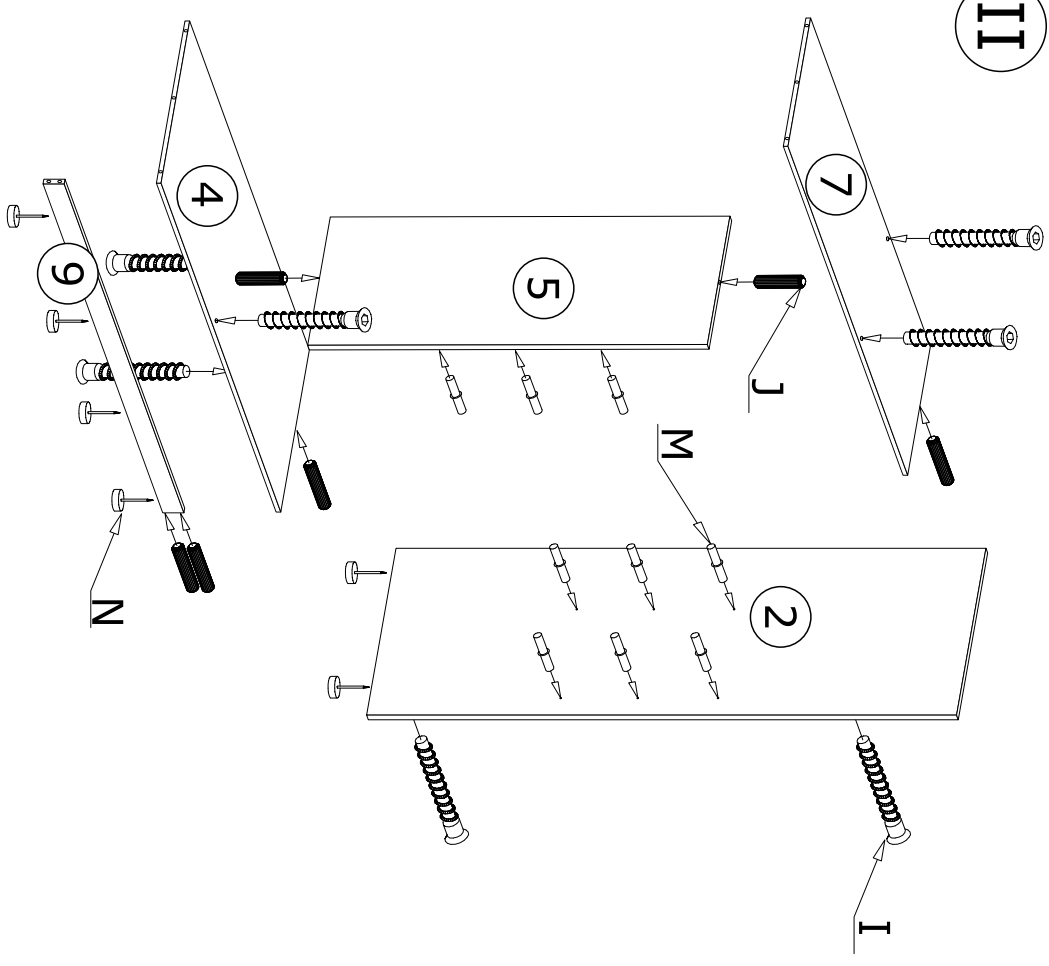

III

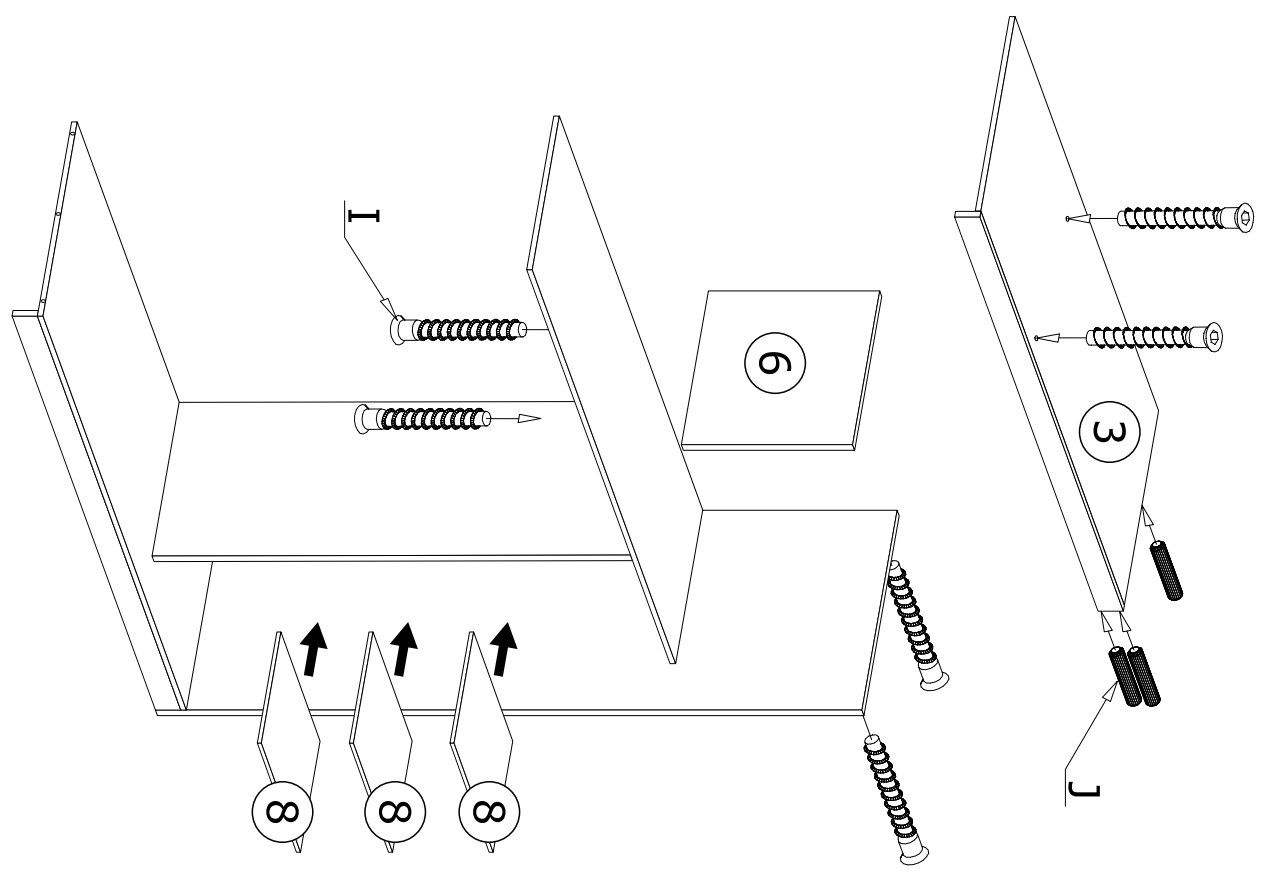

IV

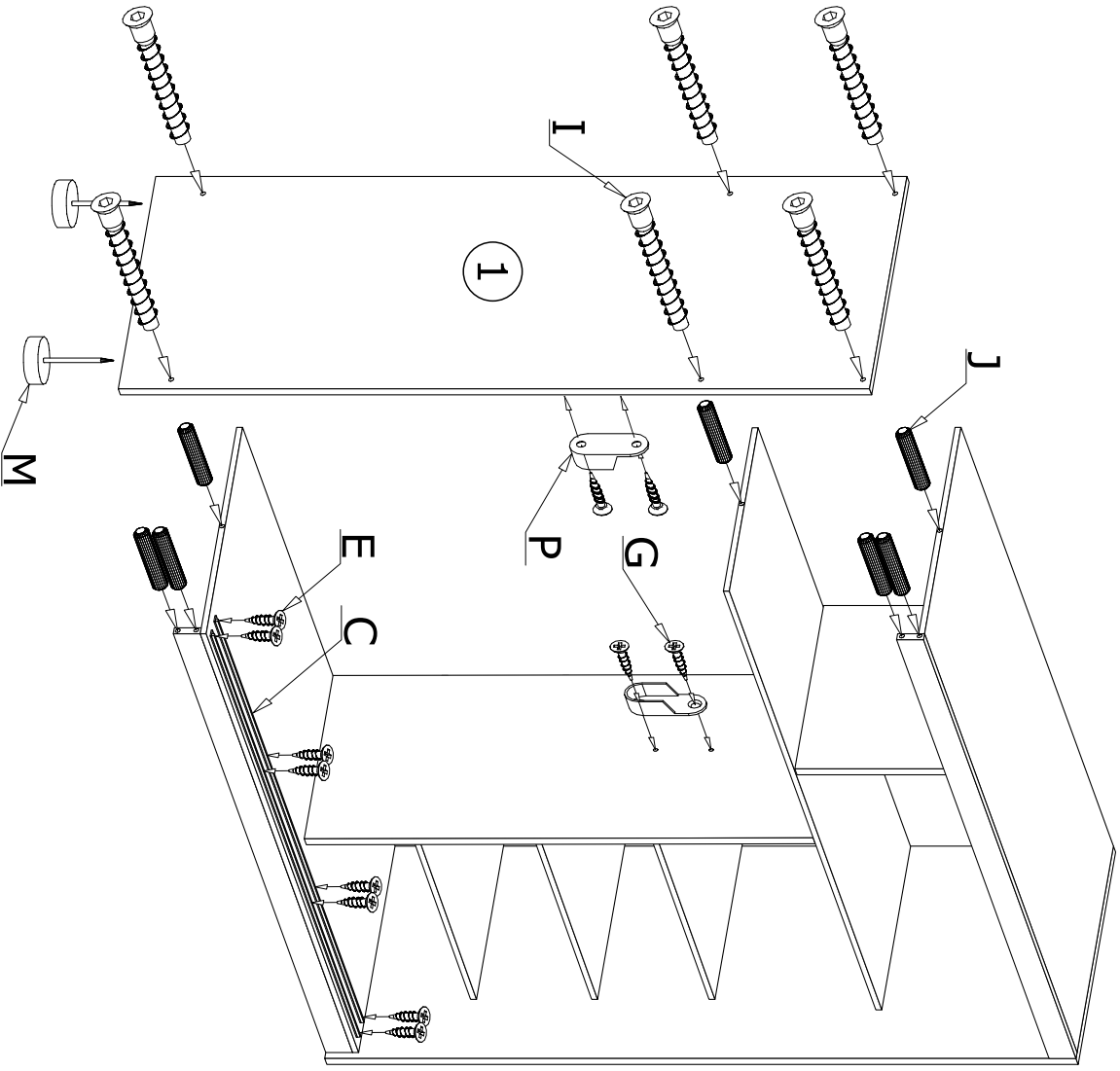

V

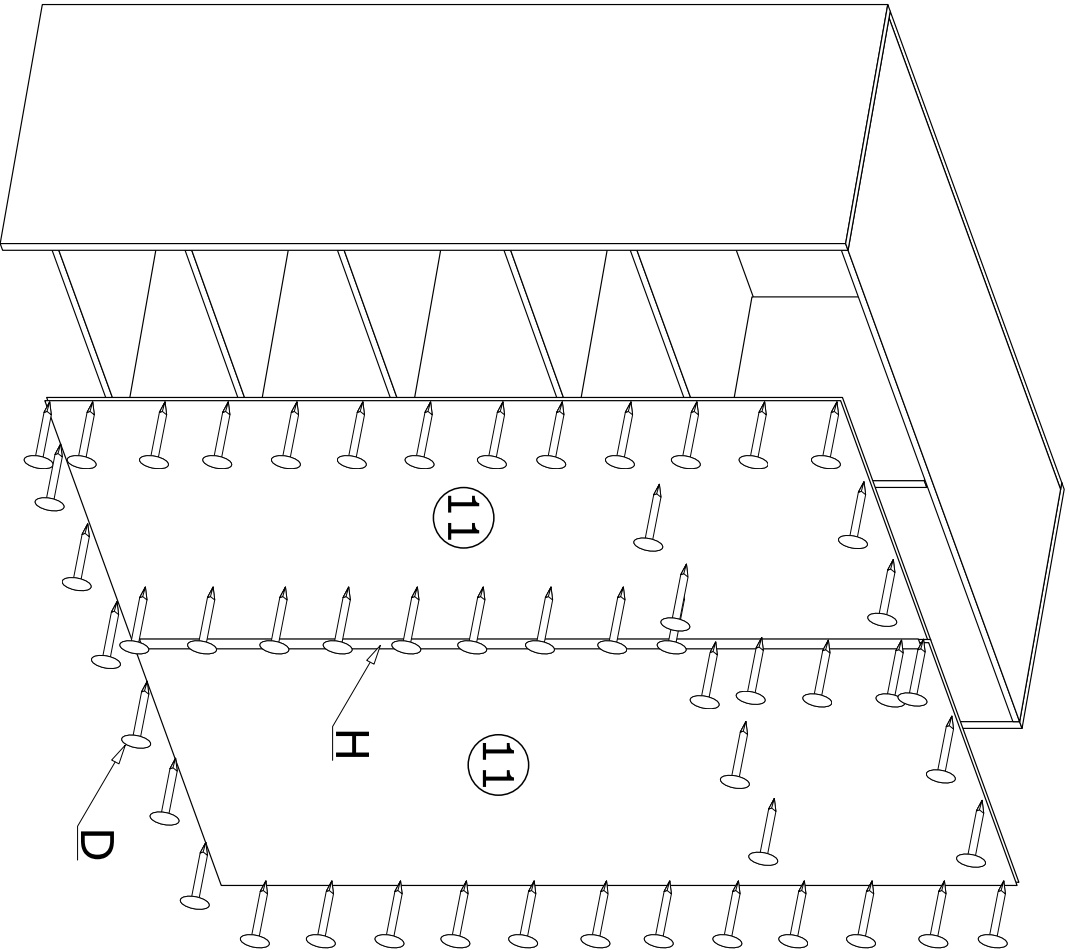

VI

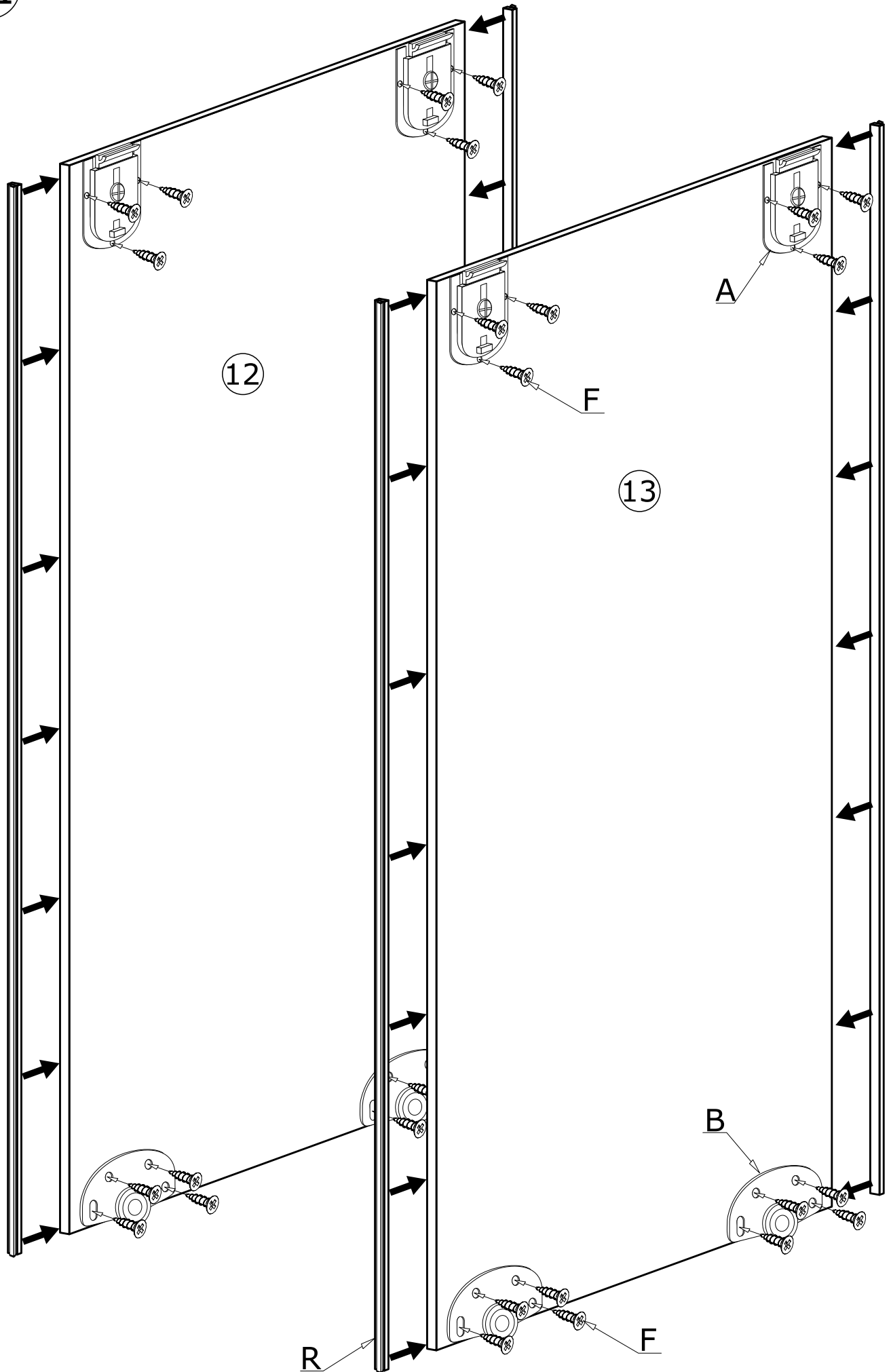

VII

