

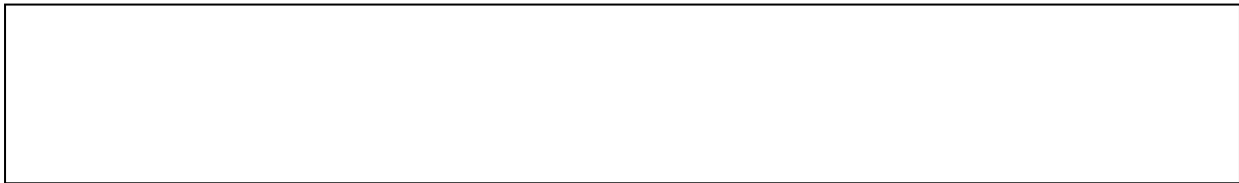

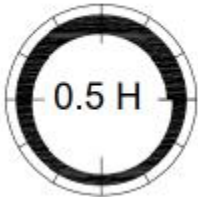

# HEAVEN-round dining table

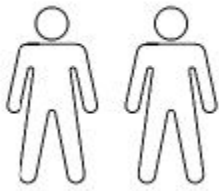

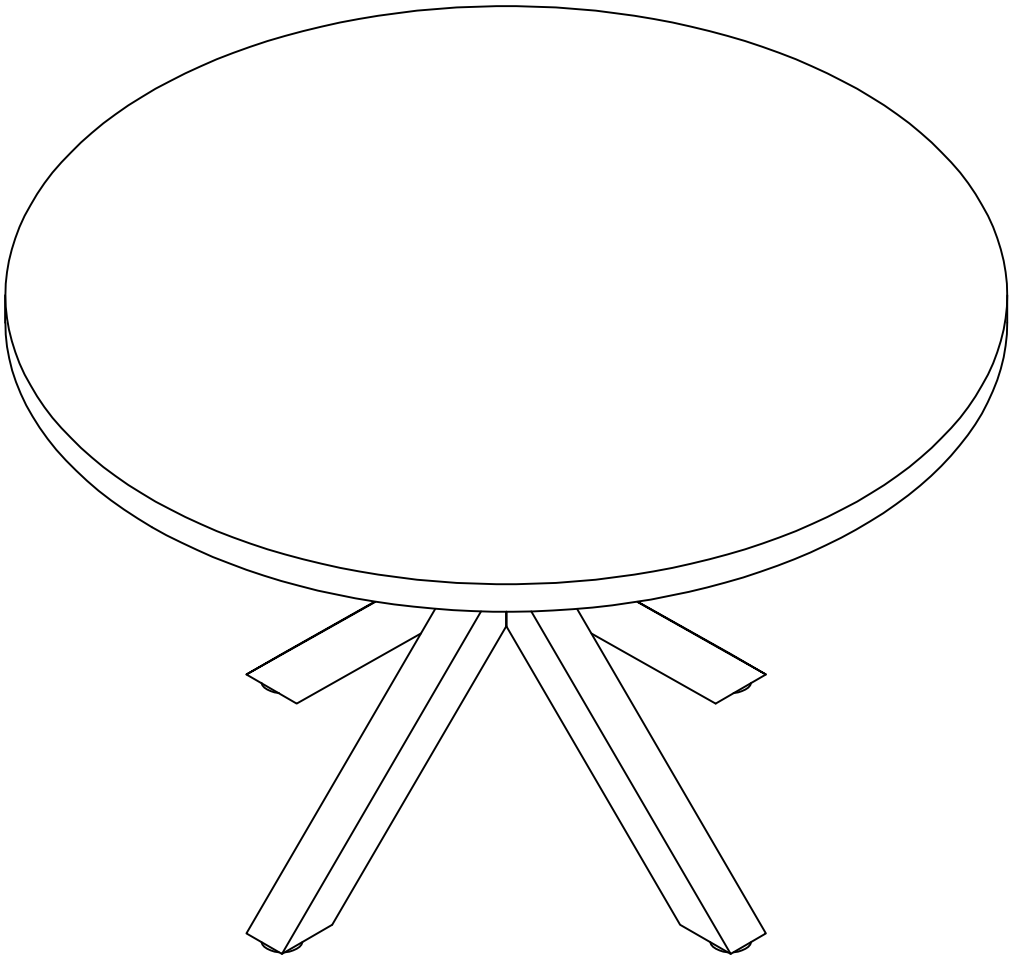
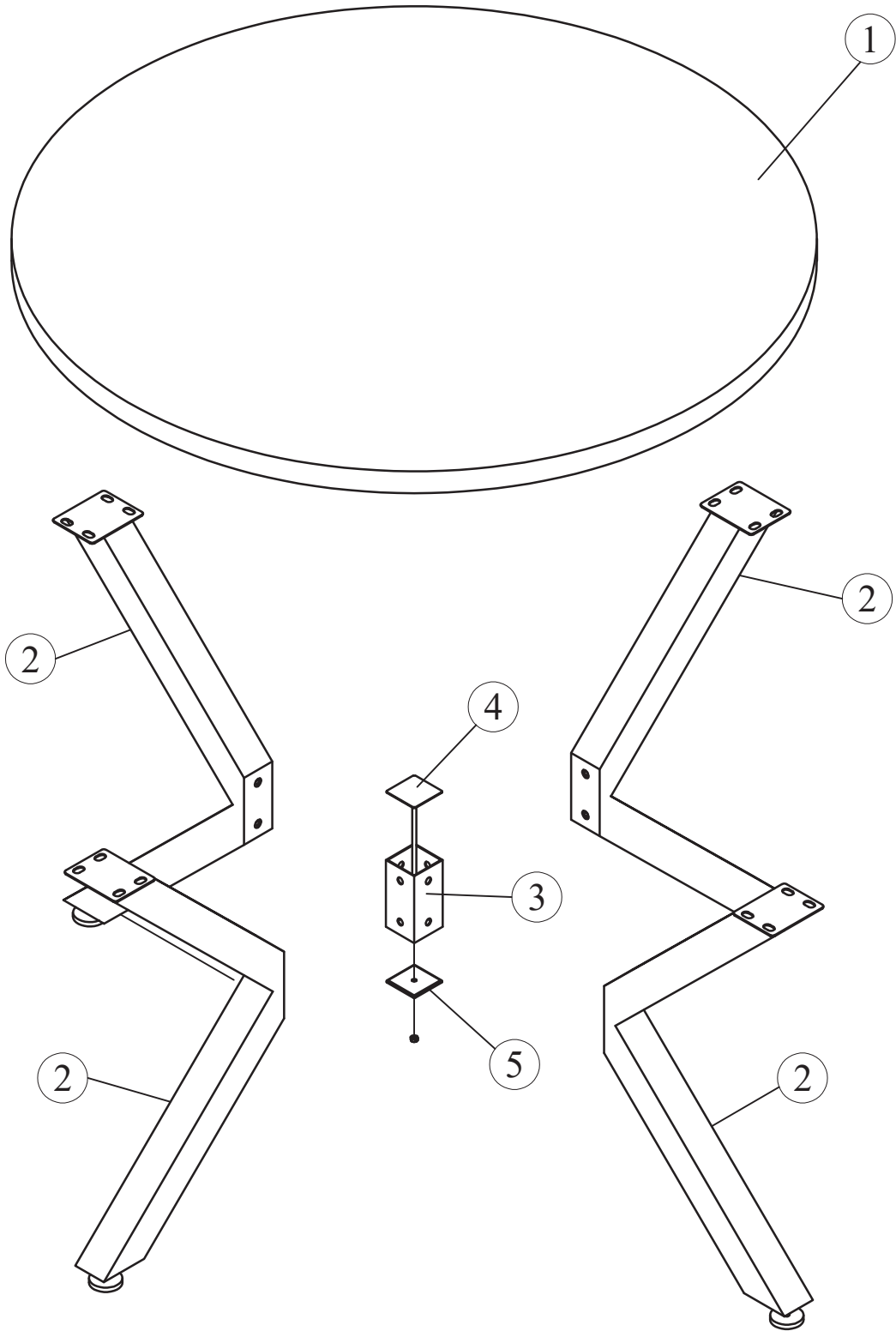
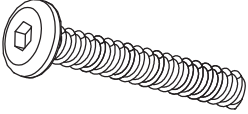
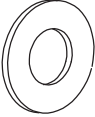

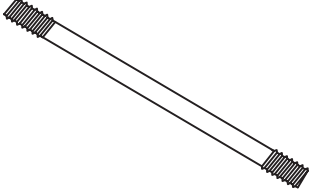
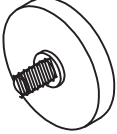
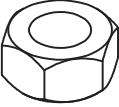
①	1	1200x1200x40
②	4	380x704x60
③	1	60x60x122
④	1	60x60x3
⑤	1	60x60x3

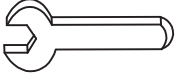



<p>Ax16</p>  <p>M8 x25 mm</p>	<p>Bx24</p>  <p>M8</p>	<p>Cx8</p>  <p>M8 x33 mm</p>	<p>Dx1</p>  <p>M6 x140 mm</p>
<p>Ex1</p>  <p>Ø50/M8 x25 mm</p>	<p>Fx1</p>  <p>M6 mm</p>	<p>Gx1</p>  <p>4mm</p>	<p>Hx1</p>  <p>6mm</p>
<p>Jx1</p>  <p>10mm</p>			

# 1

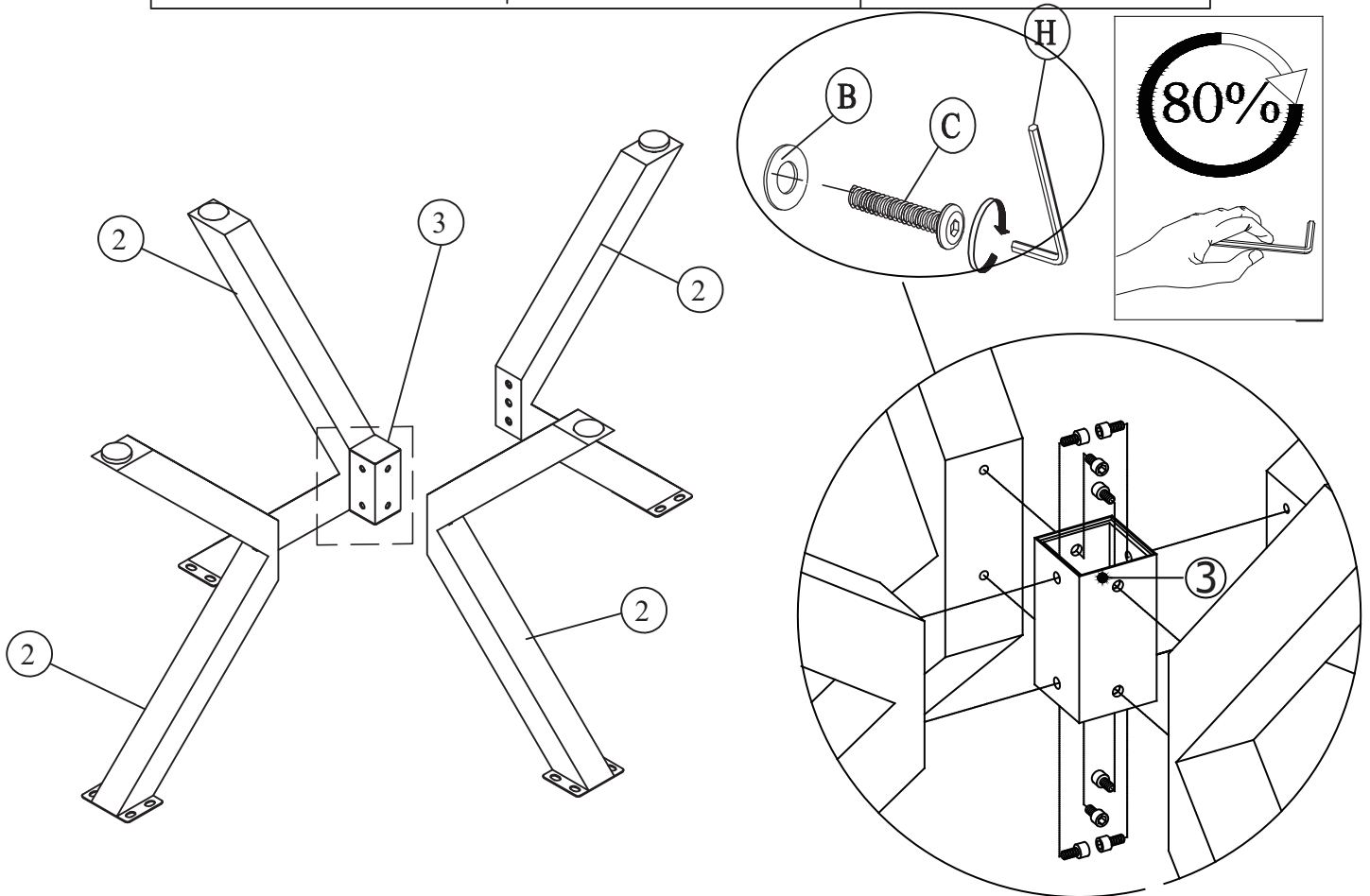

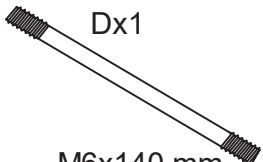
<p>Cx8</p>  <p>M8x33 mm</p>	<p>Bx24</p>  <p>M8</p>	<p>Hx1</p>  <p>6mm</p>
--	---	---

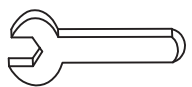

<p>Dx1</p>  <p>M6x140 mm</p>	<p>Fx1</p>  <p>M6</p>	<p>Jx1</p> 
---	--	--

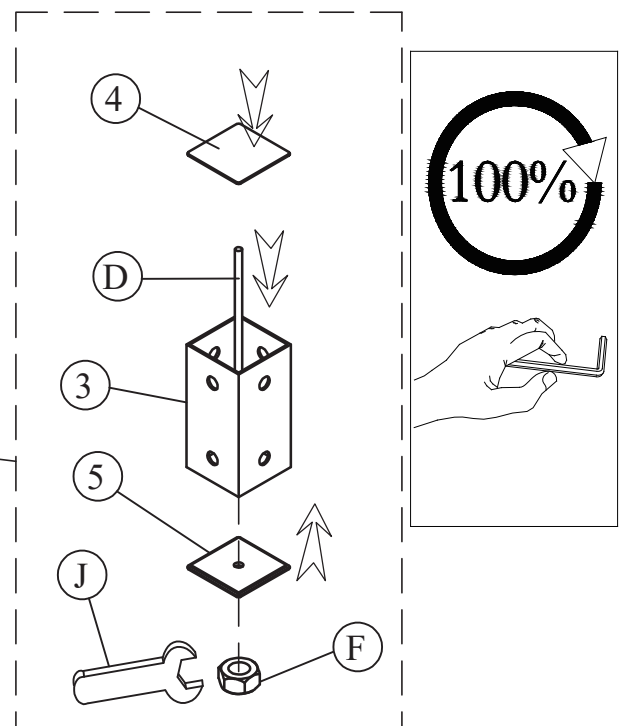
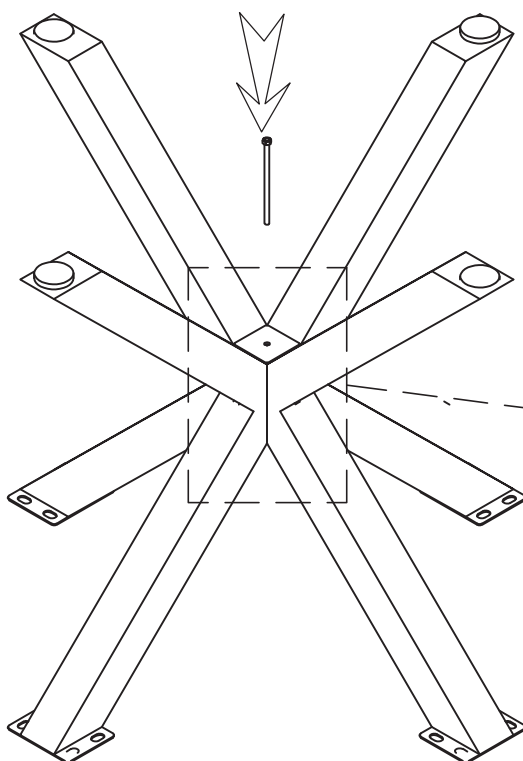
# 2

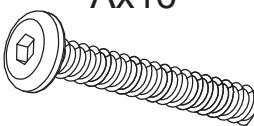

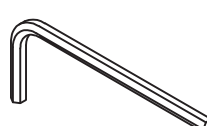
<p>Ax16</p>  <p>M8 25 mm</p>	<p>Bx24</p>  <p>M8</p>	<p>Gx1</p>  <p>4mm</p>
--	--	--

3

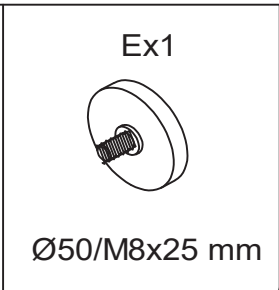
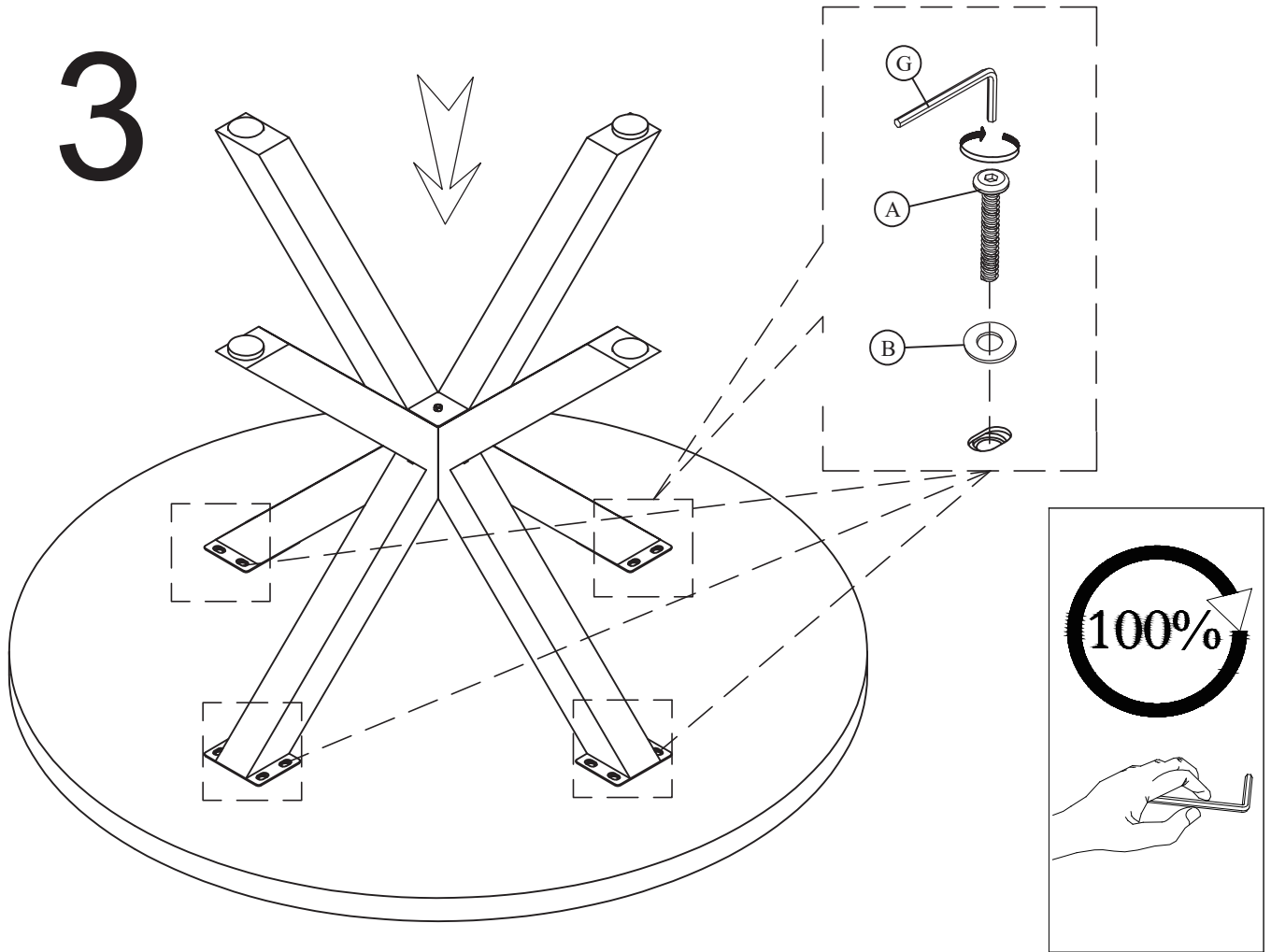

4

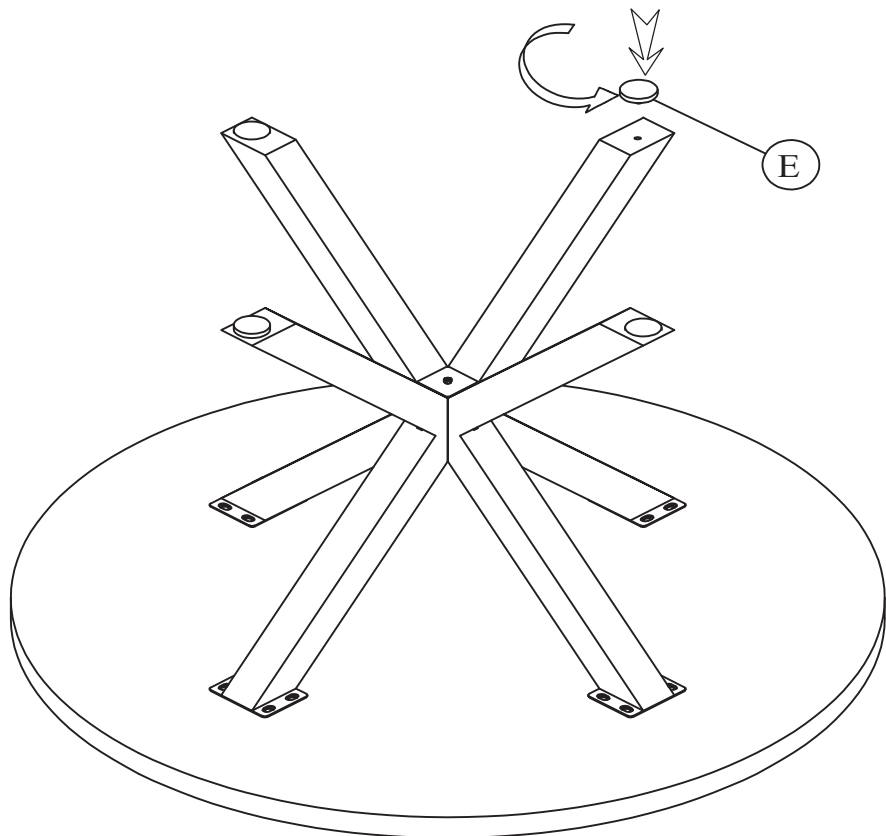

5

